



Dear Customer,  
 Congratulations for choosing this Made in Italy ATLAS FILTRI product. Please carefully read and keep this document that will help you to best enjoy and use all our products. Continue to prefer us and beware of imitations.

### TECHNICAL SPECIFICATIONS

HYDRA DS self-cleaning filters were designed and constructed with innovative technical solutions concerning filter cartridge cleaning system efficiency by washing in counter-current to remove more substances deposited on the cartridge surface.

The filter has a nominal filtration level of 90 micron in the RAH version with stainless steel net cartridges and RLH version with plastic net cartridge, or 50 micron nominal filtration in the RSH versions with pleated plastic net cartridges.

When the filtering element is clogged, it is simply cleaned by opening the valve on the bottom of the bowl (see figure 1).

This operations generates a depression in the filter that pushes the cartridge down, automatically reversing water flow from the inside (counter-current) out of the cartridge (see figure 2).

This water flow in counter-current carries particles and substances deposited on the cartridge to the drain.

Closing the valve after a couple of seconds returns pressure distribution to its initial conditions and the internal spring returns the cartridge to its service position (see figure 3).

The HYDRA DS filter features a drain funnel, which is a device designed to protect potable water in water installations against pollution, to prevent pollution by backflow, in accordance with European standard UNI EN 1717 of November 2002. This device prevents backflow by making all elements downstream from the solenoid drain valve vent to atmosphere (protection unit symbol: DC).

**WARNING:** the above described operating modes and the back-wash cleaning in counter-current occur in excellent conditions with minimum 1.8 BAR supply pressure.

**WARNING: ONLY USE THE FILTER IN THE OPERATING CONDITIONS INDICATED ON THE STICKER ON THE FILTER BOWL. IF HYDRAULIC SYSTEM PRESSURE EXCEEDS 8 BAR, A PRESSURE REDUCER MUST BE INSTALLED. INSTALLATION OF AN ANTI-WATER HAMMER DEVICE TO PROTECT THE FILTER IS RECOMMENDED.**

**FAILURE TO MEET THE OPERATING CONDITIONS MAKES THE WARRANTY VOID.**

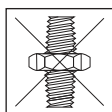

CONIC

### INSTALLATION

Before installing the filter, it is strongly recommended the installation of a by-pass and shut-off valve, while keeping both the filter inlet and outlet closed (see figure 4). Pressure gauges must be installed one before the filter, to read inlet pressure, and the other one after the filter, to read the outlet pressure.

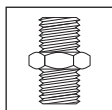

CYLINDRICAL(GAS)

Mount the filter on the wall using the support with screws (standard supply).

Connect the filter inlet and outlet connections (NB: outlet indicated by an arrow on the head) only to pipes with BSP type connections (cylindrical, GAS type) as indicated in the drawing.

**WARNING:** only use TEFLON strips to seal filter connections. Do not use other types of sealing material or the warranty shall be null and void.

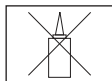

SEALANTS

### DRAIN CONNECTIONS TO THE WATER MAINS

Connect a rubber tube reinforced with canvas to the drain funnel or hose fitting at the base of the filter, secure with a clamp and have it discharge into the drain (see figures 5A and 5B). The drain point must be lower than the drain funnel or hose fitting. The rubber tube reinforced with canvas must not be more than 2 metres long.

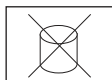

PASTE

**WARNING:** avoid bending or pinching the rubber tube reinforced with canvas: this could generate counter-pressure against the drain with consequent malfunctions.

### FILTER START-UP

As the installation of the filter and the connection of the rubber hose to the drainage are made, proceed as follows:



CANAPA

- by gradually opening water supply to the filter, make sure there are no water leaking;
- gradually fill the filter to about full and then release air in the filter as following: by opening the breather screw on the head of the filter, making sure all air is released and the filter comes completely filled with water, then tighten the breather screw;

Now the filter is ready for proper functioning.

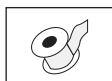

TEFLON TAPE

### WARNINGS

Only use HYDRA DS self-cleaning filters to filter mains or well water and to filter sand and other large impurities from water with pH levels between 6.5 and 8.5. Do not use the filter to filter lime. Do not filter other liquids.

**WARNING:** HYDRA DS self-cleaning filters do not make water drinkable. Do not use the filtered water as drinking water unless water quality is known. Atlas Filtri is not liable for improper HYDRA DS filter use.

### ROUTINE MAINTENANCE

Routine maintenance consists in cleaning the filter cartridge with back-wash in counter-current operation by opening the drain valve for 15/20 seconds. Back-wash in counter-current is performed as indicated in the "TECHNICAL SPECIFICATIONS" section.

If the cartridge is not perfectly clean after washing, repeat the operation with the same procedure one or more times until the desired cleanliness is reached. If acceptable cleanliness is not achieved for a good filter operations, follow the extraordinary maintenance procedure as described here following.

### Notes for a proper routine maintenance:

**Note 1:** carry-on the routine maintenance before the pressure difference between the two manometers exceeds 1 BAR.

**Note 2:** for mains water we recommend routine maintenance at least once a week, repeating the operation 2 or 3 times consecutively, if necessary, after letting suspensions decant for several seconds.

**Note 3:** for well water we recommend routine maintenance several times a week, repeating the operation 2 or 3 times consecutively, if necessary, after letting suspensions decant for several seconds.

**WARNING.** During cleaning operations water (not filtered) is still supplied.

We suggest you interrupt the water supply by closing faucets or the by-pass faucet (if installed) downstream from the filter to reach maximum pressure in counter-current and the best cartridge cleaning results.

#### EXTRAORDINARY MAINTENANCE

In time, routine cartridge cleaning may become difficult due to cloggin-up of the cartridge net. In this case, extraordinary cartridge cleaning is required as follows:

- shut-off water flow upstream from the filter;
- release the filter pressure by opening a tap downstream the filter;
- open the filter by unscrewing the bowl from the head using the supplied spanner;
- remove the cartridge (wearing protective gloves to prevent scratches due to worn net);
- clean the cartridge under a jet of cold water and use a soft brush to remove impurities;
- insert the clean cartridge in the bowl;
- screw the bowl onto the head;
- follow the procedure under "FILTER START-UP" to put the filter in service.

**WARNING:** for persistent encrustations onto the filter net or if the pressure difference between the two manometers remains above 1 BAR after cleaning the filter, replace the filter with a new one.

**WARNING:** filter cartridges and the transparent bowl have an average working life of, for that reason we recommend replacing RLH and RSH plastic net cartridges at least every 24 months and RAH stainless steel net cartridge at least every 48 months. The filter bowl must be replaced with a new one at least every 5 years.

Follow the local regulation in force when disposing cartridges and bowls.

#### TROUBLESHOOTING

HYDRA DS filters are constructed following strict quality controls and are subject to stringent efficiency and resistance tests. See here following a series of problems that may occur due to incorrect installation or maintenance or improper use, possible negligence or due to filter or filter parts consumption.

PROBLEM	CAUSE	SOLUTION
Water does not run from faucets	<ul style="list-style-type: none"><li>- cartridge clogged;</li><li>- Bowl broken;</li><li>- cut-off valves and/or By-pass closed.</li></ul>	<ul style="list-style-type: none"><li>- clean the cartridge following the extraordinary maintenance procedure;</li><li>- replace the bowl and O-ring;</li><li>- open the closed cut-off valve or by-pass.</li></ul>
Unfiltered water runs from faucets	<ul style="list-style-type: none"><li>- cartridge broken;</li><li>- spring broken;</li><li>- cartridge gasket ruined;</li><li>- by-pass valve open.</li></ul>	<ul style="list-style-type: none"><li>- replace the cartridge;</li><li>- replace the spring;</li><li>- replace the cartridge gasket;</li><li>- close the by-pass valve.</li></ul>
The cartridge does not clean during self-cleaning operation	<ul style="list-style-type: none"><li>- insufficient pressure in the bowl;</li><li>- cartridge not correctly positioned in the bowl.</li></ul>	<ul style="list-style-type: none"><li>- check the drain pipe: if pinched or bent, remove the problem;</li><li>- rotate the cartridge clockwise or Counter-clockwise so that it moves vertically without strain in the bowl.</li></ul>
Water leaks between the filter head and bowl.	<ul style="list-style-type: none"><li>- Bowl O-ring ruined</li></ul>	<ul style="list-style-type: none"><li>- replace the O-ring.</li></ul>
Water leaks from connections between pipes and from the sides of the filter	<ul style="list-style-type: none"><li>- sealant (TEFLON) insufficient</li></ul>	<ul style="list-style-type: none"><li>- add a few turns of TEFLON</li></ul>
Water leaks between the bowl and drain valve	<ul style="list-style-type: none"><li>- drain valve gasket damaged</li></ul>	<ul style="list-style-type: none"><li>- replace the gasket.</li></ul>

#### DECLARATION OF COMPLIANCE

Manufacturer's address: ATLAS FILTRI srl - Via del Santo 227, 35010 Limena (PD) - ITALY

HYDRA DS filters are constructed in accordance with the following European directives: UNI EN 1717 - Protection against pollution of potable water in water installations and general requirements of devices to prevent pollution by backflow.

**DATI TECNICI GAMMA HYDRA DS****HYDRA DS RANGE TECHNICAL SPECIFICATIONS****DONNÉES TECHNIQUES GAMME HYDRA DS****TECHNISCHE DATEN DER HYDRA DS-PRODUKTPALETTE****DATOS TÉCNICOS GAMA HYDRA DS****ТЕХНИЧЕСКИЕ ДАННЫЕ СЕРИИ HYDRA DS**

	<b>RAH</b>	<b>RLH</b>	<b>RSH</b>
IN/OUT " / ВХОД/ВЫХОД "	3/4 - 1	3/4 - 1	3/4 - 1
BAR Min / БАР Мин	1,8	1,8	1,8
BAR Max / БАР Макс	8	8	8
T°C Min / T°C Мин	+4	+4	+4
T°C Max / T°C Макс	+45	+45	+45
Micron / Микрон	90	90	50
IN/OUT 3/4" Q Max l/h @ 3 BAR / ΔP BAR @ Q Max Q Макс л/ч @ 3 BAR / ΔP БАР @ л/ч	5300/0,41	5300/0,44	5300/0,43
IN/OUT 1" Q Max l/h @ 3 BAR / ΔP BAR @ Q Max Q Макс л/ч @ 3 BAR / ΔP БАР @ л/ч	6000/0,41	6000/0,44	6000/0,43



A 168 mm  
B 428 mm



C 118 mm  
D 479 mm



E 170 mm

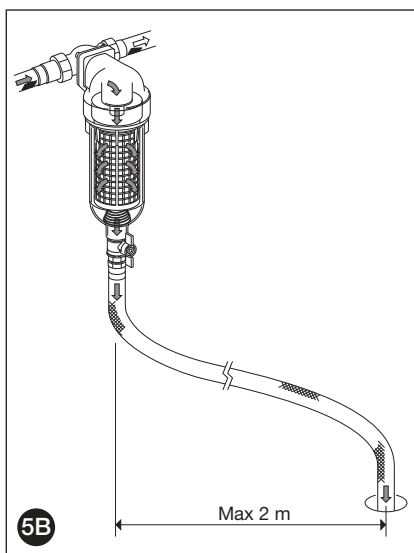
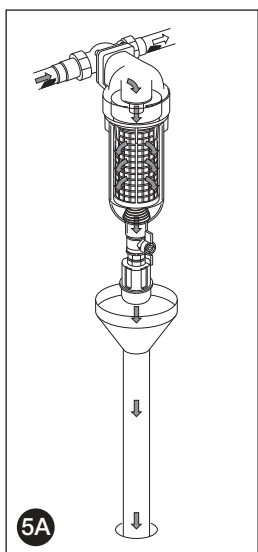
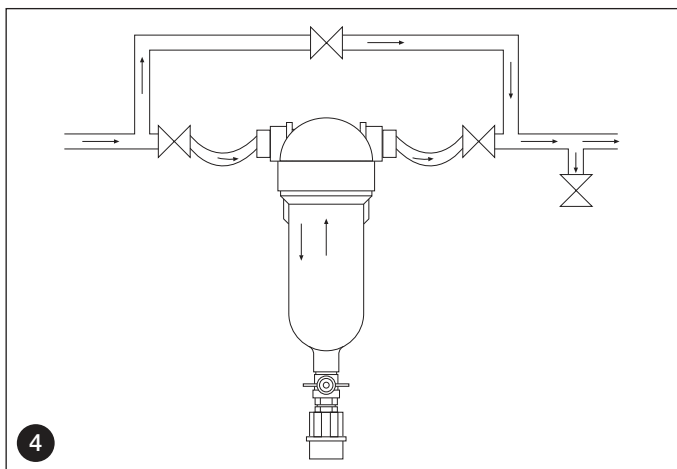
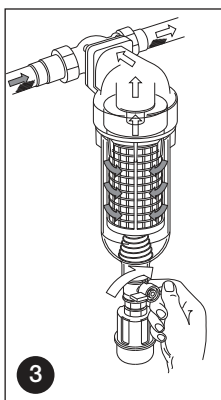
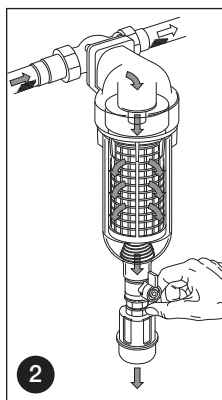
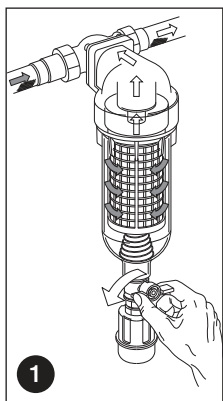

## Garanzie

- Conservare l'etichetta della scatola per identificare il prodotto.  
- I termini di garanzia applicati sono quelli contenuti nella Direttiva CEE 85/374 per i paesi UE. Per i paesi extra UE il prodotto è coperto da garanzia limitata per 12 mesi dalla data dell'acquisto provato da regolare scontrino. Richieste di risarcimento devono essere fatte per iscritto al punto vendita - o ad Atlas Filtri srl, Via del Santo 227, I-35010 Limena, Italia. Il danneggiato deve: indicare il prodotto, il luogo, la data di acquisto; offrire il prodotto in visione; provare il nesso causale tra difetto e danno. Per qualsiasi controversia il produttore elegge come Foro competente il Tribunale di Padova, Italia, con applicazione della normativa italiana.

## Warranty

- Keep the label on the box for product identification.  
- Applied warranty conditions are those in Directive CEE 85/374 for EU countries. For non EU countries, the product is covered by a limited 12-month warranty from date of purchase (proof of purchase required). Claims must be made in writing to the point of sale or to Atlas Filtri srl, Via del Santo 227, I-35010 Limena, Italy. Claims must: Indicate the product, place and date of purchase; provide the product for review; prove connections between defects and damages. All disputes are regulated by Italian law and shall be submitted to the Court of Padua, Italy.

## Garantie

- Conserver l'étiquette de la boîte pour identifier le produit.  
- Pour les pays de l'Union européenne, les délais de garantie sont ceux indiqués dans la Directive CEE 85/374. Pour les pays qui ne font pas partie de l'Union européenne, le produit est garanti 12 mois à compter de la date d'achat reportée sur le ticket de caisse. Les demandes d'indemnisation doivent être faites par écrit au point de vente ou à Atlas Filtri srl, Via del Santo 227, I-35010 Limena, Italia. Le client qui a subi un dommage doit: indiquer le produit, le lieu et la date d'achat; permettre d'examiner le produit en question; prouver le rapport entre le défaut et le dommage. En cas de litige, le fabricant reconnaît le Tribunal de Padoue (Italie) comme étant le seul compétent, avec application de la loi italienne.

## Garantie

- Bewahren Sie die Schachteletikette gut auf, um das Produkt zu identifizieren.  
- Bei den angewendeten Garantiebedingungen handelt es sich um jene, die in der Richtlinie CEE 85/374 für die Länder der EU enthalten sind. Bei Nicht-EU-Staaten ist die Garantiedeckung auf 12 Monate ab dem durch einen regulären Rechnungsbeleg bestätigten Kaufdatum beschränkt. Ansuchen um Entschädigungsansprüche müssen schriftlich bei unserer Verkaufsstelle bzw. bei Atlas Filtri srl, Via del Santo 227, I-35010 Limena, Italien gestellt werden. Der Geschädigte muss folgendermaßen vorgehen: Produktidentifikation, Ort und Datum des Kaufs sind anzugeben; das Produkt muss zur Ansicht vorgelegt werden; es ist der kausale Zusammenhang zwischen Mangel und Schaden zu beweisen. Als zuständiger Gerichtsstand für allfällige und jegliche Rechtsstreitigkeiten wurde vom Hersteller das Gericht von Padua, Italien, gewählt, wo die geltenden italienischen Rechtsvorschriften zur Anwendung gelangen.

## Garantías

- Conservar la etiqueta de la caja para identificar el producto.  
- Las condiciones de garantía aplicadas son las contenidas en la Directiva CEE 85/374 para los países de la UE. Para los países fuera de la UE el producto está cubierto por una garantía limitada por 12 meses desde la fecha de la compra, probada por el recibo correspondiente. Las eventuales solicitudes de resarcimiento se deben realizar por escrito al punto de venta - o a Atlas Filtri srl, Via del Santo 227, I-35010 Limena, Italia. El damnificado debe: indicar el producto, el lugar, la fecha de compra; ofrecer el producto para ser examinado; probar el nexo causal entre defecto y daño. Ante cualquier controversia, el fabricante elige como Foro competente el Tribunal de Padua, Italia, con aplicación de la normativa italiana.

## Гарантии

- Сохраните этикетку с коробки для идентификации изделия.  
- Для стран - членов ЕС применяются гарантийные условия, содержащиеся в Директиве CEE 85/374. Для стран - не членов ЕС, на изделие распространяется гарантия, ограниченная 12 месяцами со дня покупки, подтвержденной обычным чеком. Заявки на получение компенсации должны оформляться в письменном виде в пункте продажи, либо по адресу: Atlas Filtri srl, Via del Santo 227, I-35010 Лимена (Limena), Италия. Лицо, понесшее ущерб, должно: указать название изделия, место и дату покупки; предоставить рекламационное изделие; предоставить доказательства причинной связи между дефектом изделия и причиненным ущербом. В случае возникновения споров, изготовитель выбирает в качестве компетентного суда Суд города Падуа, Италия, с применением норм итальянского законодательства.



### **ATLAS green is the ATLAS FILTRI seal for environmentally friendly products.**

HYDRA DS filter housing bowls are made in PET, a highly recyclable plastic, manufactured with a proprietary procedure saving up to 60% of energy in injection molding compared with standard plastics. That is one of Atlas Filtri commitments to comply with Kyoto Treaty for the reduction of green house gas (CO<sub>2</sub>) emissions in the atmosphere.

