



PLUS 3P 和 2P

适用于SX滤芯的滤壳

适用于标准SX (DOE)滤芯的全系列滤壳，
高度从4英寸到20英寸。

PLUS SX 滤壳

适用于SX滤芯

PLUS SX滤壳适用于标准SX (DOE)滤芯

雅德拉斯®全系列SX滤芯适用于PLUS SX滤壳，并可配备在最大范围的水过滤和处理装置上。



SX 滤芯
带标准平面密封圈

滤壳有两个主要版本

- 适用于滤芯高度为5" , 7" , 10" , 20" 的**3P**滤壳
- 适用于滤芯高度为4" , 7" , 10"的**2P**滤壳

所有3P和2P滤壳都包含单支、DUPLEX和TRIPLEX等型号。

PLUS SX滤壳可作为单级或多级管线过滤器，适用于每一种全屋净水应用，PLUS SX滤壳秉承对于创新工艺技术和持续现代化的一贯专注，采用最优质和最先进的材料制成，确保我们产品的绝对高品质

认证



一系列滤壳依据NSF/ANSI 42, 61, 372-无铅以及CSAB483.1, 通过IAPMO RT认证, 符合美国和加拿大有关饮用水的相关规定。



产品在全球最严苛的流程下通过测试和认证，符合DM 25 (意大利)，ACS卫生认证 (法国)，EAC/Ghostreghistracia (俄罗斯) 以及WaterMark (澳大利亚) 的要求。

图例



家用



专业及工业用



滤壳由PET，一种可高度回收的塑料制成，采用专利流程，与标准塑料相比，注塑过程最多节能60%。这是雅德拉斯对减少在大气中温室气体 (CO2) 排放的承诺。

按需提供配件



-U-扳手 编号 RB7403013



-S-壁挂支架 编号 RB7400007



-D-壁挂支架 编号 RB7400009



-T-壁挂支架 编号 RB7401010



3/4" 黄铜短节, 带O型圈 (两个) 编号RB7404001

1" 黄铜短节, 带O型圈 (两个) 编号 RB7404002



3/4" 塑料短节, 带O型圈 编号 LB7404012



3/4" - 1/4" 塑料转接头, 带O型圈 编号 LB9020611



4" 扩散管 编号 LB7405002

5" 扩散管 编号 LB7405003

7" 扩散管 编号 LB7405004

10" 扩散管 编号 LB7405005



-LUBRIKIT-滤壳O型圈单次用量润滑油
编号 RE9020650

滤瓶范围



SENIOR

- 滤壳型号**
- CADET DUPLEX
 - MEDIUM DUPLEX
 - JUNIOR DUPLEX
 - SENIOR DUPLEX
 - MASTER DUPLEX



- CADET TRIPLEX
- MEDIUM TRIPLEX
- JUNIOR TRIPLEX
- SENIOR TRIPLEX
- MASTER TRIPLEX



PLUS

PLUS



PLUS M



3P

版本

3P



2P



A

进水/出水

M 1/2"

A 3/4"

B 1"

FO

螺纹类型

FO - 黄铜英国标准管螺纹*

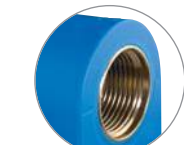

FP - 塑料英国标准管螺纹*

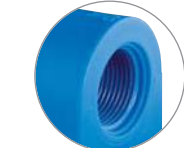

MP - 塑料英国标准管螺纹*



SX

滤芯类型

SX - 标准平面密封圈

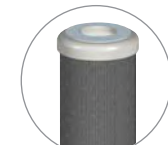

FP NPT - 塑料美国标准管螺纹**

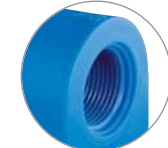

TS

壳体类型

TS - 透明 (PET)



AS - 透明 (SAN)



AB - 蓝色 (PET)

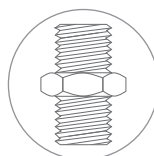

*BSP
平行管螺纹 (圆柱管)
ISO 228

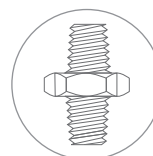

**NPT
锥管螺纹 (圆锥管)
ANSI/ASME B1.20.1



PLUS 2P SX

工作条件

最大工作压力 _____ 8 bar (116 psi)
 最高工作温度 _____ 45° C (113° F)
 最低工作温度 _____ 4° C (39.2° F)

材料规格

无毒材料, 适合于饮用水
 机头和环形螺母: 增强聚丙烯
 壳体: SAN
 O型圈: EPDM
 通气阀: 阀体聚丙烯, O型圈EPDM
 进/出水口黄铜螺纹: CW617 N黄铜

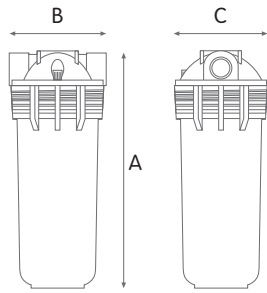

PLUS 2P SX 透明滤壳

黄铜BSP螺纹滤壳

编号	型号	适用的滤芯	进/出口	尺寸毫米		
				A	B	C
RA117P111	CADET PLUS 2P MFO SX AS	4"	1/2"	169	133	130
RA117P411	CADET PLUS 2P AFO SX AS	4"	3/4"	169	133	130
RA117P711	CADET PLUS 2P BFO SX AS	4"	1"	173	145	130
RA119P111	JUNIOR PLUS 2P MFO SX AS	7"	1/2"	241	133	130
RA119P411	JUNIOR PLUS 2P AFO SX AS	7"	3/4"	241	133	130
RA119P711	JUNIOR PLUS 2P BFO SX AS	7"	1"	247	145	130
RA121P111	SENIOR PLUS 2P MFO SX AS	10"	1/2"	315	133	130
RA121P411	SENIOR PLUS 2P AFO SX AS	10"	3/4"	315	133	130
RA121P711	SENIOR PLUS 2P BFO SX AS	10"	1"	321	145	130

塑料BSP螺纹滤壳

编号	型号	适用的滤芯	进/出口	尺寸毫米		
				A	B	C
RA117P211	CADET PLUS 2P MFP SX AS	4"	1/2"	169	133	130
RA117P511	CADET PLUS 2P AFP SX AS	4"	3/4"	169	133	130
RA117P811	CADET PLUS 2P BFP SX AS	4"	1"	173	145	130
RA119P211	JUNIOR PLUS 2P MFP SX AS	7"	1/2"	241	133	130
RA119P511	JUNIOR PLUS 2P AFP SX AS	7"	3/4"	241	133	130
RA119P811	JUNIOR PLUS 2P BFP SX AS	7"	1"	247	145	130
RA121P211	SENIOR PLUS 2P MFP SX AS	10"	1/2"	315	133	130
RA121P511	SENIOR PLUS 2P AFP SX AS	10"	3/4"	315	133	130
RA121P811	SENIOR PLUS 2P BFP SX AS	10"	1"	321	145	130

塑料NPT螺纹滤壳

编号	型号	适用的滤芯	进/出口	尺寸毫米		
				A	B	C
RA117P516	CADET PLUS 2P AFP NPT SX AS	4"	3/4"	169	133	130
RA117P816	CADET PLUS 2P BFP NPT SX AS	4"	1"	173	145	130
RA119P516	JUNIOR PLUS 2P AFP NPT SX AS	7"	3/4"	241	133	130
RA119P816	JUNIOR PLUS 2P BFP NPT SX AS	7"	1"	247	145	130
RA121P516	SENIOR PLUS 2P AFP NPT SX AS	10"	3/4"	315	133	130
RA121P816	SENIOR PLUS 2P BFP NPT SX AS	10"	1"	321	145	130

塑料BSP螺纹滤壳

编号	型号	适用的滤芯	进/出口	尺寸毫米		
				A	B	C
RA117P214	CADET PLUS 2P MMP SX AS	4"	1/2"	169	175	130
RA117P514	CADET PLUS 2P AMP SX AS	4"	3/4"	169	175	130
RA117P814	CADET PLUS 2P BMP SX AS	4"	1"	173	175	130
RA119P214	JUNIOR PLUS 2P MMP SX AS	7"	1/2"	241	175	130
RA119P514	JUNIOR PLUS 2P AMP SX AS	7"	3/4"	241	175	130
RA119P814	JUNIOR PLUS 2P BMP SX AS	7"	1"	247	175	130
RA121P214	SENIOR PLUS 2P MMP SX AS	10"	1/2"	315	175	130
RA121P514	SENIOR PLUS 2P AMP SX AS	10"	3/4"	315	175	130
RA121P814	SENIOR PLUS 2P BMP SX AS	10"	1"	321	175	130

清单中的一些型号有最小起订量和/或更长交付期限

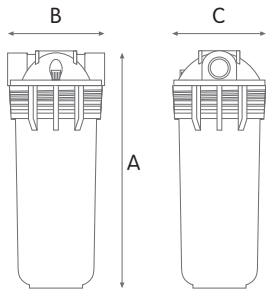

工作条件

最大工作压力 _____ 8 bar (116 psi)
 最高工作温度 _____ 45° C (113° F)
 最低工作温度 _____ 4° C (39.2° F)

材料规格

无毒材料, 适合于饮用水
 机头和环形螺母: 增强聚丙烯
 壳体: 加强聚丙烯
 O型圈: EPDM
 通气阀: 阀体聚丙烯, O型圈EPDM
 进/出水口黄铜螺纹: CW617 N黄铜

PLUS 2P SX 蓝色滤壳

黄铜BSP螺纹滤壳

编号	型号	适用的滤芯	进/出口	尺寸毫米		
				A	B	C
RA117P112	CADET PLUS 2P MFO SX AB	4"	1/2"	169	133	130
RA117P412	CADET PLUS 2P AFO SX AB	4"	3/4"	169	133	130
RA117P712	CADET PLUS 2P BFO SX AB	4"	1"	173	145	130
RA119P112	JUNIOR PLUS 2P MFO SX AB	7"	1/2"	241	133	130
RA119P412	JUNIOR PLUS 2P AFO SX AB	7"	3/4"	241	133	130
RA119P712	JUNIOR PLUS 2P BFO SX AB	7"	1"	247	145	130
RA121P112	SENIOR PLUS 2P MFO SX AB	10"	1/2"	315	133	130
RA121P412	SENIOR PLUS 2P AFO SX AB	10"	3/4"	315	133	130
RA121P712	SENIOR PLUS 2P BFO SX AB	10"	1"	321	145	130

塑料BSP螺纹滤壳

编号	型号	适用的滤芯	进/出口	尺寸毫米		
				A	B	C
RA117P212	CADET PLUS 2P MFP SX AB	4"	1/2"	169	133	130
RA117P512	CADET PLUS 2P AFP SX AB	4"	3/4"	169	133	130
RA117P812	CADET PLUS 2P BFP SX AB	4"	1"	173	145	130
RA119P212	JUNIOR PLUS 2P MFP SX AB	7"	1/2"	241	133	130
RA119P512	JUNIOR PLUS 2P AFP SX AB	7"	3/4"	241	133	130
RA119P812	JUNIOR PLUS 2P BFP SX AB	7"	1"	247	145	130
RA121P212	SENIOR PLUS 2P MFP SX AB	10"	1/2"	315	133	130
RA121P512	SENIOR PLUS 2P AFP SX AB	10"	3/4"	315	133	130
RA121P812	SENIOR PLUS 2P BFP SX AB	10"	1"	321	145	130

塑料NPT螺纹滤壳

编号	型号	适用的滤芯	进/出口	尺寸毫米		
				A	B	C
RA117P517	CADET PLUS 2P AFP NPT SX AB	4"	3/4"	169	133	130
RA117P817	CADET PLUS 2P BFP NPT SX AB	4"	1"	173	145	130
RA119P517	JUNIOR PLUS 2P AFP NPT SX AB	7"	3/4"	241	133	130
RA119P817	JUNIOR PLUS 2P BFP NPT SX AB	7"	1"	247	145	130
RA121P517	SENIOR PLUS 2P AFP NPT SX AB	10"	3/4"	315	133	130
RA121P817	SENIOR PLUS 2P BFP NPT SX AB	10"	1"	321	145	130

塑料BSP螺纹滤壳

编号	型号	适用的滤芯	进/出口	尺寸毫米		
				A	B	C
RA117P215	CADET PLUS 2P MMP SX AB	4"	1/2"	169	175	130
RA117P515	CADET PLUS 2P AMP SX AB	4"	3/4"	169	175	130
RA117P815	CADET PLUS 2P BMP SX AB	4"	1"	173	175	130
RA119P215	JUNIOR PLUS 2P MMP SX AB	7"	1/2"	241	175	130
RA119P515	JUNIOR PLUS 2P AMP SX AB	7"	3/4"	241	175	130
RA119P815	JUNIOR PLUS 2P BMP SX AB	7"	1"	247	175	130
RA121P215	SENIOR PLUS 2P MMP SX AB	10"	1/2"	315	175	130
RA121P515	SENIOR PLUS 2P AMP SX AB	10"	3/4"	315	175	130
RA121P815	SENIOR PLUS 2P BMP SX AB	10"	1"	321	175	130

清单中的一些型号有最小起订量和/或更长交付期限



PLUS M 2P SX

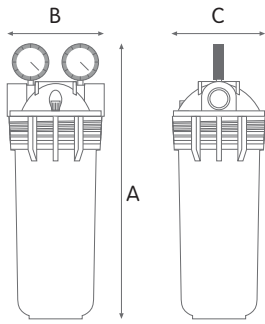

工作条件

最大工作压力 _____ 8 bar (116 psi)
 最高工作温度 _____ 45° C (113° F)
 最低工作温度 _____ 4° C (39.2° F)

材料规格

无毒材料, 适合于饮用水
 机头和环形螺母: 增强聚丙烯
 壳体: SAN
 O型圈: EPDM
 通气阀: 阀体聚丙烯, O型圈EPDM
 进/出水口黄铜螺纹: CW617 N黄铜
 压力表: 放射状读数盘, 压力范围0-12 bar, 0-170 psi

PLUS M 2P SX 透明双压力表滤壳

黄铜BSP螺纹滤壳

编号	型号	适用的滤芯	进/出口	尺寸毫米		
				A	B	C
RA117P114	CADET PLUS M 2P MFO SX AS	4"	1/2"	219	133	130
RA117P414	CADET PLUS M 2P AFO SX AS	4"	3/4"	219	133	130
RA117P714	CADET PLUS M 2P BFO SX AS	4"	1"	225	145	130
RA119P114	JUNIOR PLUS M 2P MFO SX AS	7"	1/2"	291	133	130
RA119P414	JUNIOR PLUS M 2P AFO SX AS	7"	3/4"	291	133	130
RA119P714	JUNIOR PLUS M 2P BFO SX AS	7"	1"	297	145	130
RA121P114	SENIOR PLUS M 2P MFO SX AS	10"	1/2"	365	133	130
RA121P414	SENIOR PLUS M 2P AFO SX AS	10"	3/4"	365	133	130
RA121P714	SENIOR PLUS M 2P BFO SX AS	10"	1"	371	145	130

塑料BSP螺纹滤壳

编号	型号	适用的滤芯	进/出口	尺寸毫米		
				A	B	C
RA117P418	CADET PLUS M 2P AFP SX AS	4"	3/4"	219	133	130
RA117P718	CADET PLUS M 2P BFP SX AS	4"	1"	225	145	130
RA119P418	JUNIOR PLUS M 2P AFP SX AS	7"	3/4"	291	133	130
RA119P718	JUNIOR PLUS M 2P BFP SX AS	7"	1"	297	145	130
RA121P418	SENIOR PLUS M 2P AFP SX AS	10"	3/4"	365	133	130
RA121P718	SENIOR PLUS M 2P BFP SX AS	10"	1"	371	145	130

塑料NPT螺纹滤壳

编号	型号	适用的滤芯	进/出口	尺寸毫米		
				A	B	C
RA117P518	CADET PLUS M 2P AFP NPT SX AS	4"	3/4"	219	133	130
RA117P818	CADET PLUS M 2P BFP NPT SX AS	4"	1"	225	145	130
RA119P518	JUNIOR PLUS M 2P AFP NPT SX AS	7"	3/4"	291	133	130
RA119P818	JUNIOR PLUS M 2P BFP NPT SX AS	7"	1"	297	145	130
RA121P518	SENIOR PLUS M 2P AFP NPT SX AS	10"	3/4"	365	133	130
RA121P818	SENIOR PLUS M 2P BFP NPT SX AS	10"	1"	371	145	130

清单中的一些型号有最小起订量和/或更长交付期限

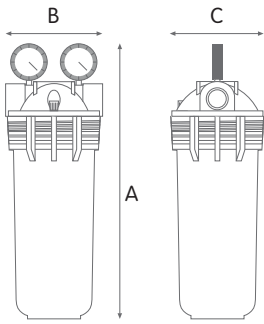

工作条件

最大工作压力 _____ 8 bar (116 psi)
 最高工作温度 _____ 45° C (113° F)
 最低工作温度 _____ 4° C (39.2° F)

材料规格

无毒材料, 适合于饮用水
 机头和环形螺母: 增强聚丙烯
 壳体: 加强聚丙烯
 O型圈: EPDM
 通气阀: 阀体聚丙烯, O型圈EPDM
 进/出水口黄铜螺纹: CW617 N黄铜
 压力表: 放射状读数盘, 压力范围0-12 bar, 0-170 psi

PLUS M 2P SX 蓝色双压力表滤壳

黄铜BSP螺纹滤壳

编号	型号	适用的滤芯	进/出口	尺寸毫米		
				A	B	C
RA117P115	CADET PLUS M 2P MFO SX AB	4"	1/2"	219	133	130
RA117P415	CADET PLUS M 2P AFO SX AB	4"	3/4"	219	133	130
RA117P715	CADET PLUS M 2P BFO SX AB	4"	1"	225	145	130
RA119P115	JUNIOR PLUS M 2P MFO SX AB	7"	1/2"	291	133	130
RA119P415	JUNIOR PLUS M 2P AFO SX AB	7"	3/4"	291	133	130
RA119P715	JUNIOR PLUS M 2P BFO SX AB	7"	1"	297	145	130
RA121P115	SENIOR PLUS M 2P MFO SX AB	10"	1/2"	365	133	130
RA121P415	SENIOR PLUS M 2P AFO SX AB	10"	3/4"	365	133	130
RA121P715	SENIOR PLUS M 2P BFO SX AB	10"	1"	371	145	130

塑料BSP螺纹滤壳

编号	型号	适用的滤芯	进/出口	尺寸毫米		
				A	B	C
RA117P419	CADET PLUS M 2P AFP SX AB	4"	3/4"	219	133	130
RA117P719	CADET PLUS M 2P BFP SX AB	4"	1"	225	145	130
RA119P419	JUNIOR PLUS M 2P AFP SX AB	7"	3/4"	291	133	130
RA119P719	JUNIOR PLUS M 2P BFP SX AB	7"	1"	297	145	130
RA121P419	SENIOR PLUS M 2P AFP SX AB	10"	3/4"	365	133	130
RA121P719	SENIOR PLUS M 2P BFP SX AB	10"	1"	371	145	130

塑料NPT螺纹滤壳

编号	型号	适用的滤芯	进/出口	尺寸毫米		
				A	B	C
RA117P519	CADET PLUS M 2P AFP NPT SX AB	4"	3/4"	219	133	130
RA117P819	CADET PLUS M 2P BFP NPT SX AB	4"	1"	225	145	130
RA119P519	JUNIOR PLUS M 2P AFP NPT SX AB	7"	3/4"	291	133	130
RA119P819	JUNIOR PLUS M 2P BFP NPT SX AB	7"	1"	297	145	130
RA121P519	SENIOR PLUS M 2P AFP NPT SX AB	10"	3/4"	365	133	130
RA121P819	SENIOR PLUS M 2P BFP NPT SX AB	10"	1"	371	145	130



DUPLEX PLUS 2P SX

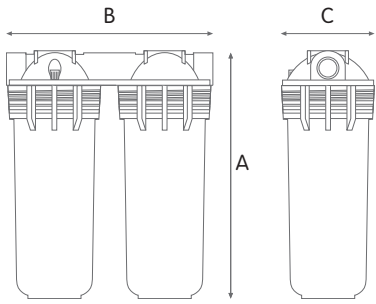

工作条件

最大工作压力 _____ 8 bar (116 psi)
 最高工作温度 _____ 45° C (113° F)
 最低工作温度 _____ 4° C (39,2° F)

材料规格

无毒材料, 适合于饮用水
 机头和环形螺母: 增强聚丙烯
 壳体: SAN
 O型圈: EPDM
 通气阀: 阀体聚丙烯, O型圈EPDM
 进/出水口黄铜螺纹: CW617 N黄铜

DUPLEX PLUS 2P SX 透明滤壳

黄铜BSP螺纹滤壳

编号	型号	适用的滤芯	进/出口	尺寸毫米		
				A	B	C
RA118P411	CADET DUPLEX PLUS 2P AF0 SX AS	4"	3/4"	169	275	130
RA118P711	CADET DUPLEX PLUS 2P BF0 SX AS	4"	1"	169	275	130
RA120P411	JUNIOR DUPLEX PLUS 2P AF0 SX AS	7"	3/4"	241	275	130
RA120P711	JUNIOR DUPLEX PLUS 2P BF0 SX AS	7"	1"	241	275	130
RA122P411	SENIOR DUPLEX PLUS 2P AF0 SX AS	10"	3/4"	315	275	130
RA122P711	SENIOR DUPLEX PLUS 2P BF0 SX AS	10"	1"	315	275	130

塑料BSP螺纹滤壳

编号	型号	适用的滤芯	进/出口	尺寸毫米		
				A	B	C
RA118P511	CADET DUPLEX PLUS 2P AFP SX AS	4"	3/4"	169	275	130
RA120P511	JUNIOR DUPLEX PLUS 2P AFP SX AS	7"	3/4"	241	275	130
RA122P511	SENIOR DUPLEX PLUS 2P AFP SX AS	10"	3/4"	315	275	130

塑料NPT螺纹滤壳

编号	型号	适用的滤芯	进/出口	尺寸毫米		
				A	B	C
RA118P513	CADET DUPLEX PLUS 2P AFP NPT SX AS	4"	3/4"	169	275	130
RA120P513	JUNIOR DUPLEX PLUS 2P AFP NPT SX AS	7"	3/4"	241	275	130
RA122P513	SENIOR DUPLEX PLUS 2P AFP NPT SX AS	10"	3/4"	315	275	130

清单中的一些型号有最小起订量和/或更长交付期限

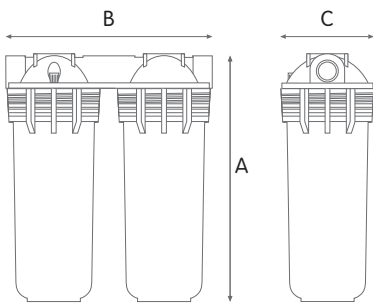

工作条件

最大工作压力 _____ 8 bar (116 psi)
 最高工作温度 _____ 45° C (113° F)
 最低工作温度 _____ 4° C (39.2° F)

材料规格

无毒材料, 适合于饮用水
 机头和环形螺母: 增强聚丙烯
 壳体: 加强聚丙烯
 O型圈: EPDM
 通气阀: 阀体聚丙烯, O型圈EPDM
 进/出水口黄铜螺纹: CW617 N黄铜

DUPLEX PLUS 2P SX 蓝色滤壳

黄铜BSP螺纹滤壳

编号	型号	适用的滤芯	进/出口	尺寸毫米		
				A	B	C
RA118P412	CADET DUPLEX PLUS 2P AFO SX AB	4"	3/4"	169	275	130
RA118P712	CADET DUPLEX PLUS 2P BFO SX AB	4"	1"	169	275	130
RA120P412	JUNIOR DUPLEX PLUS 2P AFO SX AB	7"	3/4"	241	275	130
RA120P712	JUNIOR DUPLEX PLUS 2P BFO SX AB	7"	1"	241	275	130
RA122P412	SENIOR DUPLEX PLUS 2P AFO SX AB	10"	3/4"	315	275	130
RA122P712	SENIOR DUPLEX PLUS 2P BFO SX AB	10"	1"	315	275	130

塑料BSP螺纹滤壳

编号	型号	适用的滤芯	进/出口	尺寸毫米		
				A	B	C
RA118P512	CADET DUPLEX PLUS 2P AFP SX AB	4"	3/4"	169	275	130
RA120P512	JUNIOR DUPLEX PLUS 2P AFP SX AB	7"	3/4"	241	275	130
RA122P512	SENIOR DUPLEX PLUS 2P AFP SX AB	10"	3/4"	315	275	130

塑料NPT螺纹滤壳

编号	型号	适用的滤芯	进/出口	尺寸毫米		
				A	B	C
RA118P514	CADET DUPLEX PLUS 2P AFP NPT SX AB	4"	3/4"	169	275	130
RA120P514	JUNIOR DUPLEX PLUS 2P AFP NPT SX AB	7"	3/4"	241	275	130
RA122P514	SENIOR DUPLEX PLUS 2P AFP NPT SX AB	10"	3/4"	315	275	130



TRIPLEX PLUS 2P SX

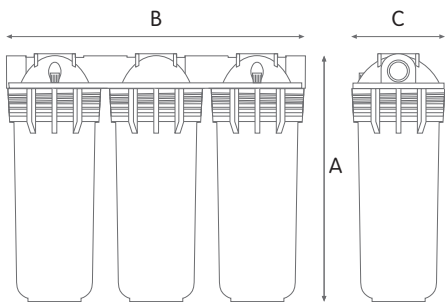

工作条件

最大工作压力 _____ 8 bar (116 psi)
 最高工作温度 _____ 45° C (113° F)
 最低工作温度 _____ 4° C (39.2° F)

材料规格

无毒材料，适合于饮用水
 机头和环形螺母：增强聚丙烯
 壳体：SAN
 O型圈：EPDM
 通气阀：阀体聚丙烯，O型圈EPDM
 进/出水口黄铜螺纹：CW617 N黄铜



TRIPLEX PLUS 2P SX 透明滤壳

黄铜BSP螺纹滤壳

编号	型号	适用的滤芯	进/出口	尺寸毫米		
				A	B	C
RA118P431	CADET TRIPLEX PLUS 2P AF0 SX AS	4"	3/4"	169	420	130
RA118P731	CADET TRIPLEX PLUS 2P BF0 SX AS	4"	1"	169	420	130
RA120P431	JUNIOR TRIPLEX PLUS 2P AF0 SX AS	7"	3/4"	241	420	130
RA120P731	JUNIOR TRIPLEX PLUS 2P BF0 SX AS	7"	1"	241	420	130
RA122P431	SENIOR TRIPLEX PLUS 2P AF0 SX AS	10"	3/4"	315	420	130
RA122P731	SENIOR TRIPLEX PLUS 2P BF0 SX AS	10"	1"	315	420	130

塑料BSP螺纹滤壳

编号	型号	适用的滤芯	进/出口	尺寸毫米		
				A	B	C
RA118P531	CADET TRIPLEX PLUS 2P AFP SX AS	4"	3/4"	169	420	130
RA118P831	CADET TRIPLEX PLUS 2P BFP SX AS	4"	1"	169	420	130
RA120P531	JUNIOR TRIPLEX PLUS 2P AFP SX AS	7"	3/4"	241	420	130
RA120P831	JUNIOR TRIPLEX PLUS 2P BFP SX AS	7"	1"	241	420	130
RA122P531	SENIOR TRIPLEX PLUS 2P AFP SX AS	10"	3/4"	315	420	130
RA122P831	SENIOR TRIPLEX PLUS 2P BFP SX AS	10"	1"	315	420	130

塑料NPT螺纹滤壳

编号	型号	适用的滤芯	进/出口	尺寸毫米		
				A	B	C
RA118P533	CADET TRIPLEX PLUS 2P AFP NPT SX AS	4"	3/4"	169	420	130
RA120P533	JUNIOR TRIPLEX PLUS 2P AFP NPT SX AS	7"	3/4"	241	420	130
RA122P533	SENIOR TRIPLEX PLUS 2P AFP NPT SX AS	10"	3/4"	315	420	130

清单中的一些型号有最小起订量和/或更长交付期限

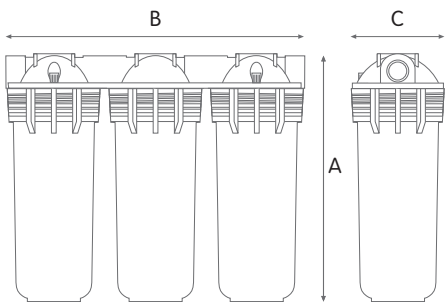

工作条件

最大工作压力 _____ 8 bar (116 psi)
 最高工作温度 _____ 45° C (113° F)
 最低工作温度 _____ 4° C (39.2° F)

材料规格

无毒材料, 适合于饮用水
 机头和环形螺母: 增强聚丙烯
 壳体: 加强聚丙烯
 O型圈: EPDM
 通气阀: 阀体聚丙烯, O型圈EPDM
 进/出水口黄铜螺纹: CW617 N黄铜

TRIPLEX PLUS 2P SX 蓝色滤壳

黄铜BSP螺纹滤壳

编号	型号	适用的滤芯 进/出口		尺寸毫米		
				A	B	C
RA118P432	CADET TRIPLEX PLUS 2P AFO SX AB	4"	3/4"	169	420	130
RA118P732	CADET TRIPLEX PLUS 2P BFO SX AB	4"	1"	169	420	130
RA120P432	JUNIOR TRIPLEX PLUS 2P AFO SX AB	7"	3/4"	241	420	130
RA120P732	JUNIOR TRIPLEX PLUS 2P BFO SX AB	7"	1"	241	420	130
RA122P432	SENIOR TRIPLEX PLUS 2P AFO SX AB	10"	3/4"	315	420	130
RA122P732	SENIOR TRIPLEX PLUS 2P BFO SX AB	10"	1"	315	420	130

塑料BSP螺纹滤壳

编号	型号	适用的滤芯 进/出口		尺寸毫米		
				A	B	C
RA118P532	CADET TRIPLEX PLUS 2P AFP SX AB	4"	3/4"	169	420	130
RA118P832	CADET TRIPLEX PLUS 2P BFP SX AB	4"	1"	169	420	130
RA120P532	JUNIOR TRIPLEX PLUS 2P AFP SX AB	7"	3/4"	241	420	130
RA120P832	JUNIOR TRIPLEX PLUS 2P BFP SX AB	7"	1"	241	420	130
RA122P532	SENIOR TRIPLEX PLUS 2P AFP SX AB	10"	3/4"	315	420	130
RA122P832	SENIOR TRIPLEX PLUS 2P BFP SX AB	10"	1"	315	420	130

塑料NPT螺纹滤壳

编号	型号	适用的滤芯 进/出口		尺寸毫米		
				A	B	C
RA118P534	CADET TRIPLEX PLUS 2P AFP NPT SX AB	4"	3/4"	169	420	130
RA120P534	JUNIOR TRIPLEX PLUS 2P AFP NPT SX AB	7"	3/4"	241	420	130
RA122P534	SENIOR TRIPLEX PLUS 2P AFP NPT SX AB	10"	3/4"	315	420	130

清单中的一些型号有最小起订量和/或更长交付期限