



## PLUS 3P<sub>and</sub> 2P

filter housings for cartridges SX

Full range of housings designed to fit to standard SX (DOE) cartridges with height from 4" to 20".

# HOUSINGS PLUS SX

## FOR CARTRIDGES SX

### Housings PLUS SX fit to standard SX (DOE) cartridges.

The full range of Atlas Filtri® SX cartridges is suitable to PLUS SX housings and provide the widest range of water filtration and treatment units.



**SX** cartridges with standard flat seals.

The housings are made in 2 main versions:

- **3P** housings for cartridge height at 5", 7", 10", 20".
- **2P** housings for cartridge height at 4", 7", 10".

All 3P and 2P housings are available as single, DUPLEX and TRIPLEX models.

PLUS SX housings are suitable for every Point-of-Entry (POE) application, as single or multi-stage on-line filters.

PLUS SX housings are manufactured with the finest and most advanced materials under constant focus on innovative processing technologies and ceaseless modernization to ensure the absolute quality of our products.

## CERTIFICATIONS



A range of housings is certified by IAPMO RT to NSF/ANSI 42, 61, 372 - lead free, CSA B483.1. In compliance with drinking water regulations, USA and Canada.



The products are tested and certified under the most stringent procedures worldwide, in compliance with DM 25 (Italy), with the sanitary certification ACS (France), EAC/Ghostreghistracia (Russia) and WaterMark (Australia).

## SYMBOLS LEGEND



For domestic use



For technical and industrial use



Filter housings made in PET, a highly recyclable plastic, are manufactured with a proprietary procedure saving up to 60% of energy in injection molding compared with standard plastics. That is one of Atlas Filtri commitments for the reduction of green house gas (CO<sub>2</sub>) emissions in the atmosphere.

## ACCESSORIES ON DEMAND



-U- spanner CODE RB7403013



-S- wall bracket CODE RB7400007



-D- wall bracket CODE RB7400009



-T- wall bracket CODE RB7401010



3/4" brass nipples with o-ring (pair) CODE RB7404001

1" brass nipples with o-ring (pair) CODE RB7404002



3/4" plastic nipple with o-ring CODE LB7404012



3/4"-1/4" plastic reduction with o-ring CODE LB9020611



4" diffuser tubes CODE LB7405002

5" diffuser tubes CODE LB7405003

7" diffuser tubes CODE LB7405004

10" diffuser tubes CODE LB7405005



-LUBRIKIT- single-dose lubricant for housing o-ring  
CODE RE9020650

HOUSINGS RANGE



| SENIOR  | PLUS   | 3P   | A  | FO   | SX  | TS   |
|---|--|--|--|--|---|--|
| HOUSINGS MODEL  | VERSION  | IN / OUT   | THREADS TYPE   | CARTRIDGE TYPE   | BOWL TYPE   |  |
| <ul style="list-style-type: none"> <li>CADET DUPLEX</li> <li>MEDIUM DUPLEX</li> <li>JUNIOR DUPLEX</li> <li>SENIOR DUPLEX</li> <li>MASTER DUPLEX</li> </ul>      | <ul style="list-style-type: none"> <li>PLUS</li> </ul>   | <ul style="list-style-type: none"> <li>3P</li> </ul> | <ul style="list-style-type: none"> <li>M 1/2"</li> <li>A 3/4"</li> <li>B 1"</li> </ul>           | <ul style="list-style-type: none"> <li>FO - BRASS BSP *</li> </ul>                     | <ul style="list-style-type: none"> <li>SX - STANDARD FLAT SEALS</li> </ul>                  | <ul style="list-style-type: none"> <li>TS - CLEAR (PET)</li> </ul>                           |
| <ul style="list-style-type: none"> <li>CADET TRIPLEX</li> <li>MEDIUM TRIPLEX</li> <li>JUNIOR TRIPLEX</li> <li>SENIOR TRIPLEX</li> <li>MASTER TRIPLEX</li> </ul> | <ul style="list-style-type: none"> <li>PLUS M</li> </ul> | <ul style="list-style-type: none"> <li>2P</li> </ul> | <ul style="list-style-type: none"> <li>FP - PLASTIC BSP *</li> <li>MP - PLASTIC BSP *</li> </ul> | <ul style="list-style-type: none"> <li>FP NPT - PLASTIC NPT **</li> </ul>              | <ul style="list-style-type: none"> <li>AS - CLEAR (SAN)</li> <li>AB - BLUE (PET)</li> </ul> |  |
|   |  |  |  | <ul style="list-style-type: none"> <li>* BSP parallel (cylindrical) ISO 228</li> </ul> |   | <ul style="list-style-type: none"> <li>** NPT tapered (conical) ANSI/ASME B1.20.1</li> </ul> |



# PLUS 3P SX

## WORKING CONDITIONS

Max working pressure:  
 BSP versions \_\_\_\_\_ 8 bar (116 psi)  
 NPT versions \_\_\_\_\_ 8,6 bar (125 psi)  
 Max working temperature \_\_\_\_\_ 45°C (113°F)  
 Min working temperature \_\_\_\_\_ 4°C (39,2°F)

## SPECIFICATIONS

Non-toxic materials, suitable for drinking water.  
 Head and ring nut: reinforced polypropylene.  
 Bowl: PET.  
 O-ring: EPDM.  
 Breather-valve: body polypropylene, o-ring EPDM.  
 IN/OUT brass threads: CW 614 N brass.

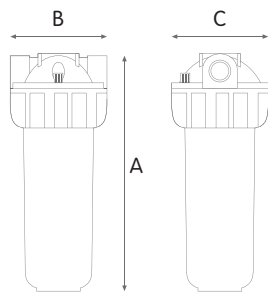

## PLUS 3P SX clear housings

### HOUSINGS WITH BRASS BSP THREADS

| CODE      | MODEL                    | SUITABLE CARTRIDGE | IN/OUT | DIMENSIONS mm |     |     |
|-----------|--------------------------|--------------------|--------|---------------|-----|-----|
|           |                          |                    |        | A             | B   | C   |
| RA107T111 | MEDIUM PLUS 3P MFO SX TS | 5"                 | 1/2"   | 191           | 133 | 130 |
| RA107T411 | MEDIUM PLUS 3P AFO SX TS | 5"                 | 3/4"   | 191           | 133 | 130 |
| RA107T711 | MEDIUM PLUS 3P BFO SX TS | 5"                 | 1"     | 197           | 145 | 130 |
| RA109T111 | JUNIOR PLUS 3P MFO SX TS | 7"                 | 1/2"   | 241           | 133 | 130 |
| RA109T411 | JUNIOR PLUS 3P AFO SX TS | 7"                 | 3/4"   | 241           | 133 | 130 |
| RA109T711 | JUNIOR PLUS 3P BFO SX TS | 7"                 | 1"     | 247           | 145 | 130 |
| RA111T111 | SENIOR PLUS 3P MFO SX TS | 10"                | 1/2"   | 315           | 133 | 130 |
| RA111T411 | SENIOR PLUS 3P AFO SX TS | 10"                | 3/4"   | 315           | 133 | 130 |
| RA111T711 | SENIOR PLUS 3P BFO SX TS | 10"                | 1"     | 321           | 145 | 130 |
| RA115T111 | MASTER PLUS 3P MFO SX TS | 20"                | 1/2"   | 571           | 133 | 130 |
| RA115T411 | MASTER PLUS 3P AFO SX TS | 20"                | 3/4"   | 571           | 133 | 130 |
| RA115T711 | MASTER PLUS 3P BFO SX TS | 20"                | 1"     | 577           | 145 | 130 |

### HOUSINGS WITH PLASTIC BSP THREADS

| CODE      | MODEL                    | SUITABLE CARTRIDGE | IN/OUT | DIMENSIONS mm |     |     |
|-----------|--------------------------|--------------------|--------|---------------|-----|-----|
|           |                          |                    |        | A             | B   | C   |
| RA107T211 | MEDIUM PLUS 3P MFP SX TS | 5"                 | 1/2"   | 191           | 133 | 130 |
| RA107T511 | MEDIUM PLUS 3P AFP SX TS | 5"                 | 3/4"   | 191           | 133 | 130 |
| RA107T811 | MEDIUM PLUS 3P BFP SX TS | 5"                 | 1"     | 197           | 145 | 130 |
| RA109T211 | JUNIOR PLUS 3P MFP SX TS | 7"                 | 1/2"   | 241           | 133 | 130 |
| RA109T511 | JUNIOR PLUS 3P AFP SX TS | 7"                 | 3/4"   | 241           | 133 | 130 |
| RA109T811 | JUNIOR PLUS 3P BFP SX TS | 7"                 | 1"     | 247           | 145 | 130 |
| RA111T211 | SENIOR PLUS 3P MFP SX TS | 10"                | 1/2"   | 315           | 133 | 130 |
| RA111T511 | SENIOR PLUS 3P AFP SX TS | 10"                | 3/4"   | 315           | 133 | 130 |
| RA111T811 | SENIOR PLUS 3P BFP SX TS | 10"                | 1"     | 321           | 145 | 130 |
| RA115T211 | MASTER PLUS 3P MFP SX TS | 20"                | 1/2"   | 571           | 133 | 130 |
| RA115T511 | MASTER PLUS 3P AFP SX TS | 20"                | 3/4"   | 571           | 133 | 130 |
| RA115T811 | MASTER PLUS 3P BFP SX TS | 20"                | 1"     | 577           | 145 | 130 |

### HOUSINGS WITH PLASTIC NPT THREADS

| CODE      | MODEL                        | SUITABLE CARTRIDGE | IN/OUT | DIMENSIONS mm |     |     |
|-----------|------------------------------|--------------------|--------|---------------|-----|-----|
|           |                              |                    |        | A             | B   | C   |
| RA107T513 | MEDIUM PLUS 3P AFP NPT SX TS | 5"                 | 3/4"   | 191           | 133 | 130 |
| RA107T813 | MEDIUM PLUS 3P BFP NPT SX TS | 5"                 | 1"     | 197           | 145 | 130 |
| RA109T513 | JUNIOR PLUS 3P AFP NPT SX TS | 7"                 | 3/4"   | 241           | 133 | 130 |
| RA109T813 | JUNIOR PLUS 3P BFP NPT SX TS | 7"                 | 1"     | 247           | 145 | 130 |
| RA111T610 | SENIOR PLUS 3P AFP NPT SX TS | 10"                | 3/4"   | 315           | 133 | 130 |
| RA111T611 | SENIOR PLUS 3P BFP NPT SX TS | 10"                | 1"     | 321           | 145 | 130 |
| RA115T611 | MASTER PLUS 3P AFP NPT SX TS | 20"                | 3/4"   | 571           | 133 | 130 |
| RA115T813 | MASTER PLUS 3P BFP NPT SX TS | 20"                | 1"     | 577           | 145 | 130 |

### HOUSINGS WITH PLASTIC BSP THREADS

| CODE      | MODEL                    | SUITABLE CARTRIDGE | IN/OUT | DIMENSIONS mm |     |     |
|-----------|--------------------------|--------------------|--------|---------------|-----|-----|
|           |                          |                    |        | A             | B   | C   |
| RA107T215 | MEDIUM PLUS 3P MMP SX TS | 5"                 | 1/2"   | 191           | 175 | 130 |
| RA107T515 | MEDIUM PLUS 3P AMP SX TS | 5"                 | 3/4"   | 191           | 175 | 130 |
| RA107T815 | MEDIUM PLUS 3P BMP SX TS | 5"                 | 1"     | 197           | 175 | 130 |
| RA109T215 | JUNIOR PLUS 3P MMP SX TS | 7"                 | 1/2"   | 241           | 175 | 130 |
| RA109T515 | JUNIOR PLUS 3P AMP SX TS | 7"                 | 3/4"   | 241           | 175 | 130 |
| RA109T815 | JUNIOR PLUS 3P BMP SX TS | 7"                 | 1"     | 247           | 175 | 130 |
| RA111T215 | SENIOR PLUS 3P MMP SX TS | 10"                | 1/2"   | 315           | 175 | 130 |
| RA111T515 | SENIOR PLUS 3P AMP SX TS | 10"                | 3/4"   | 315           | 175 | 130 |
| RA111T815 | SENIOR PLUS 3P BMP SX TS | 10"                | 1"     | 321           | 175 | 130 |
| RA115T215 | MASTER PLUS 3P MMP SX TS | 20"                | 1/2"   | 571           | 175 | 130 |
| RA115T515 | MASTER PLUS 3P AMP SX TS | 20"                | 3/4"   | 571           | 175 | 130 |
| RA115T815 | MASTER PLUS 3P BMP SX TS | 20"                | 1"     | 577           | 175 | 130 |

## VARIANTS AVAILABLE ON MINIMUM QUANTITY:

- RT housings suitable for filter cartridges with length 508 mm

Some items in the list are subject to minimum order quantities and/or to longer delivery term.

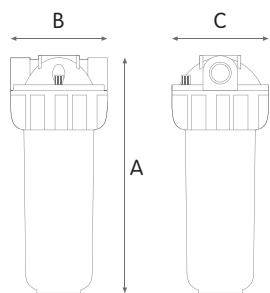

**WORKING CONDITIONS**

Max working pressure:  
 BSP versions \_\_\_\_\_ 8 bar (116 psi)  
 NPT versions \_\_\_\_\_ 8,6 bar (125 psi)  
 Max working temperature \_\_\_\_\_ 45°C (113°F)  
 Min working temperature \_\_\_\_\_ 4°C (39,2°F)

**SPECIFICATIONS**

Non-toxic materials, suitable for drinking water.  
 Head and ring nut: reinforced polypropylene.  
 Bowl: PET.  
 O-ring: EPDM.  
 Breather-valve: body polypropylene, o-ring EPDM.  
 IN/OUT brass threads: CW 614 N brass.

**PLUS 3P SX blue housings**

**HOUSINGS WITH BRASS BSP THREADS**

| CODE      | MODEL                    | SUITABLE CARTRIDGE | IN/OUT | DIMENSIONS mm |     |     |
|-----------|--------------------------|--------------------|--------|---------------|-----|-----|
|           |                          |                    |        | A             | B   | C   |
| RA107T112 | MEDIUM PLUS 3P MFO SX AB | 5"                 | 1/2"   | 191           | 133 | 130 |
| RA107T412 | MEDIUM PLUS 3P AFO SX AB | 5"                 | 3/4"   | 191           | 133 | 130 |
| RA107T712 | MEDIUM PLUS 3P BFO SX AB | 5"                 | 1"     | 197           | 145 | 130 |
| RA109T112 | JUNIOR PLUS 3P MFO SX AB | 7"                 | 1/2"   | 241           | 133 | 130 |
| RA109T412 | JUNIOR PLUS 3P AFO SX AB | 7"                 | 3/4"   | 241           | 133 | 130 |
| RA109T712 | JUNIOR PLUS 3P BFO SX AB | 7"                 | 1"     | 247           | 145 | 130 |
| RA111T112 | SENIOR PLUS 3P MFO SX AB | 10"                | 1/2"   | 315           | 133 | 130 |
| RA111T412 | SENIOR PLUS 3P AFO SX AB | 10"                | 3/4"   | 315           | 133 | 130 |
| RA111T712 | SENIOR PLUS 3P BFO SX AB | 10"                | 1"     | 321           | 145 | 130 |
| RA115T112 | MASTER PLUS 3P MFO SX AB | 20"                | 1/2"   | 571           | 133 | 130 |
| RA115T412 | MASTER PLUS 3P AFO SX AB | 20"                | 3/4"   | 571           | 133 | 130 |
| RA115T712 | MASTER PLUS 3P BFO SX AB | 20"                | 1"     | 577           | 145 | 130 |

**HOUSINGS WITH PLASTIC BSP THREADS**

| CODE      | MODEL                    | SUITABLE CARTRIDGE | IN/OUT | DIMENSIONS mm |     |     |
|-----------|--------------------------|--------------------|--------|---------------|-----|-----|
|           |                          |                    |        | A             | B   | C   |
| RA107T212 | MEDIUM PLUS 3P MFP SX AB | 5"                 | 1/2"   | 191           | 133 | 130 |
| RA107T512 | MEDIUM PLUS 3P AFP SX AB | 5"                 | 3/4"   | 191           | 133 | 130 |
| RA107T812 | MEDIUM PLUS 3P BFP SX AB | 5"                 | 1"     | 197           | 145 | 130 |
| RA109T212 | JUNIOR PLUS 3P MFP SX AB | 7"                 | 1/2"   | 241           | 133 | 130 |
| RA109T512 | JUNIOR PLUS 3P AFP SX AB | 7"                 | 3/4"   | 241           | 133 | 130 |
| RA109T812 | JUNIOR PLUS 3P BFP SX AB | 7"                 | 1"     | 247           | 145 | 130 |
| RA111T212 | SENIOR PLUS 3P MFP SX AB | 10"                | 1/2"   | 315           | 133 | 130 |
| RA111T512 | SENIOR PLUS 3P AFP SX AB | 10"                | 3/4"   | 315           | 133 | 130 |
| RA111T812 | SENIOR PLUS 3P BFP SX AB | 10"                | 1"     | 321           | 145 | 130 |
| RA115T212 | MASTER PLUS 3P MFP SX AB | 20"                | 1/2"   | 571           | 133 | 130 |
| RA115T512 | MASTER PLUS 3P AFP SX AB | 20"                | 3/4"   | 571           | 133 | 130 |
| RA115T812 | MASTER PLUS 3P BFP SX AB | 20"                | 1"     | 577           | 145 | 130 |

**HOUSINGS WITH PLASTIC NPT THREADS**

| CODE      | MODEL                        | SUITABLE CARTRIDGE | IN/OUT | DIMENSIONS mm |     |     |
|-----------|------------------------------|--------------------|--------|---------------|-----|-----|
|           |                              |                    |        | A             | B   | C   |
| RA107T514 | MEDIUM PLUS 3P AFP NPT SX AB | 5"                 | 3/4"   | 191           | 133 | 130 |
| RA107T814 | MEDIUM PLUS 3P BFP NPT SX AB | 5"                 | 1"     | 197           | 145 | 130 |
| RA109T514 | JUNIOR PLUS 3P AFP NPT SX AB | 7"                 | 3/4"   | 241           | 133 | 130 |
| RA109T814 | JUNIOR PLUS 3P BFP NPT SX AB | 7"                 | 1"     | 247           | 145 | 130 |
| RA111T612 | SENIOR PLUS 3P AFP NPT SX AB | 10"                | 3/4"   | 315           | 133 | 130 |
| RA111T613 | SENIOR PLUS 3P BFP NPT SX AB | 10"                | 1"     | 321           | 145 | 130 |
| RA115T612 | MASTER PLUS 3P AFP NPT SX AB | 20"                | 3/4"   | 571           | 133 | 130 |
| RA115T814 | MASTER PLUS 3P BFP NPT SX AB | 20"                | 1"     | 577           | 145 | 130 |

**HOUSINGS WITH PLASTIC BSP THREADS**

| CODE      | MODEL                    | SUITABLE CARTRIDGE | IN/OUT | DIMENSIONS mm |     |     |
|-----------|--------------------------|--------------------|--------|---------------|-----|-----|
|           |                          |                    |        | A             | B   | C   |
| RA107T216 | MEDIUM PLUS 3P MMP SX AB | 5"                 | 1/2"   | 191           | 175 | 130 |
| RA107T516 | MEDIUM PLUS 3P AMP SX AB | 5"                 | 3/4"   | 191           | 175 | 130 |
| RA107T816 | MEDIUM PLUS 3P BMP SX AB | 5"                 | 1"     | 197           | 175 | 130 |
| RA109T216 | JUNIOR PLUS 3P MMP SX AB | 7"                 | 1/2"   | 241           | 175 | 130 |
| RA109T516 | JUNIOR PLUS 3P AMP SX AB | 7"                 | 3/4"   | 241           | 175 | 130 |
| RA109T816 | JUNIOR PLUS 3P BMP SX AB | 7"                 | 1"     | 247           | 175 | 130 |
| RA111T216 | SENIOR PLUS 3P MMP SX AB | 10"                | 1/2"   | 315           | 175 | 130 |
| RA111T516 | SENIOR PLUS 3P AMP SX AB | 10"                | 3/4"   | 315           | 175 | 130 |
| RA111T816 | SENIOR PLUS 3P BMP SX AB | 10"                | 1"     | 321           | 175 | 130 |
| RA115T216 | MASTER PLUS 3P MMP SX AB | 20"                | 1/2"   | 571           | 175 | 130 |
| RA115T516 | MASTER PLUS 3P AMP SX AB | 20"                | 3/4"   | 571           | 175 | 130 |
| RA115T816 | MASTER PLUS 3P BMP SX AB | 20"                | 1"     | 577           | 175 | 130 |

**VARIANTS AVAILABLE ON MINIMUM QUANTITY:**

- RT housings suitable for filter cartridges with length 508 mm

Some items in the list are subject to minimum order quantities and/or to longer delivery term.



# PLUS M 3P SX

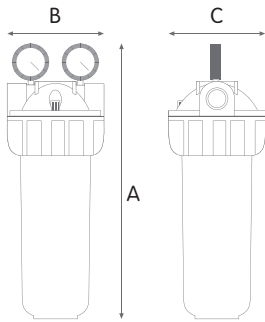

## WORKING CONDITIONS

Max working pressure:  
 BSP versions \_\_\_\_\_ 8 bar (116 psi)  
 NPT versions \_\_\_\_\_ 8,6 bar (125 psi)  
 Max working temperature \_\_\_\_\_ 45°C (113°F)  
 Min working temperature \_\_\_\_\_ 4°C (39,2°F)

## SPECIFICATIONS

Non-toxic materials, suitable for drinking water.  
 Head and ring nut: reinforced polypropylene.  
 Bowl: PET.  
 O-ring: EPDM.  
 Breather-valve: body polypropylene, o-ring EPDM.  
 IN/OUT brass threads: CW 614 N brass.  
 Manometers: radial type, pressure range 0-12 bar, 0-170 psi.

## PLUS M 3P SX clear housings with 2 manometers

### HOUSINGS WITH BRASS BSP THREADS

| CODE      | MODEL                      | SUITABLE CARTRIDGE | IN/OUT | DIMENSIONS mm |     |     |
|-----------|----------------------------|--------------------|--------|---------------|-----|-----|
|           |                            |                    |        | A             | B   | C   |
| RA107T114 | MEDIUM PLUS M 3P MFO SX TS | 5"                 | 1/2"   | 241           | 133 | 130 |
| RA107T414 | MEDIUM PLUS M 3P AFO SX TS | 5"                 | 3/4"   | 241           | 133 | 130 |
| RA107T714 | MEDIUM PLUS M 3P BFO SX TS | 5"                 | 1"     | 247           | 145 | 130 |
| RA109T114 | JUNIOR PLUS M 3P MFO SX TS | 7"                 | 1/2"   | 291           | 133 | 130 |
| RA109T414 | JUNIOR PLUS M 3P AFO SX TS | 7"                 | 3/4"   | 291           | 133 | 130 |
| RA109T714 | JUNIOR PLUS M 3P BFO SX TS | 7"                 | 1"     | 297           | 145 | 130 |
| RA111T114 | SENIOR PLUS M 3P MFO SX TS | 10"                | 1/2"   | 365           | 133 | 130 |
| RA111T414 | SENIOR PLUS M 3P AFO SX TS | 10"                | 3/4"   | 365           | 133 | 130 |
| RA111T714 | SENIOR PLUS M 3P BFO SX TS | 10"                | 1"     | 371           | 145 | 130 |
| RA115T114 | MASTER PLUS M 3P MFO SX TS | 20"                | 1/2"   | 621           | 133 | 130 |
| RA115T414 | MASTER PLUS M 3P AFO SX TS | 20"                | 3/4"   | 621           | 133 | 130 |
| RA115T714 | MASTER PLUS M 3P BFO SX TS | 20"                | 1"     | 627           | 145 | 130 |

### HOUSINGS WITH PLASTIC BSP THREADS

| CODE      | MODEL                      | SUITABLE CARTRIDGE | IN/OUT | DIMENSIONS mm |     |     |
|-----------|----------------------------|--------------------|--------|---------------|-----|-----|
|           |                            |                    |        | A             | B   | C   |
| RA107T418 | MEDIUM PLUS M 3P AFP SX TS | 5"                 | 3/4"   | 241           | 133 | 130 |
| RA107T718 | MEDIUM PLUS M 3P BFP SX TS | 5"                 | 1"     | 247           | 145 | 130 |
| RA109T418 | JUNIOR PLUS M 3P AFP SX TS | 7"                 | 3/4"   | 291           | 133 | 130 |
| RA109T718 | JUNIOR PLUS M 3P BFP SX TS | 7"                 | 1"     | 297           | 145 | 130 |
| RA111T418 | SENIOR PLUS M 3P AFP SX TS | 10"                | 3/4"   | 365           | 133 | 130 |
| RA111T718 | SENIOR PLUS M 3P BFP SX TS | 10"                | 1"     | 371           | 145 | 130 |
| RA115T418 | MASTER PLUS M 3P AFP SX TS | 20"                | 3/4"   | 621           | 133 | 130 |
| RA115T718 | MASTER PLUS M 3P BFP SX TS | 20"                | 1"     | 627           | 145 | 130 |

### HOUSINGS WITH PLASTIC NPT THREADS

| CODE      | MODEL                          | SUITABLE CARTRIDGE | IN/OUT | DIMENSIONS mm |     |     |
|-----------|--------------------------------|--------------------|--------|---------------|-----|-----|
|           |                                |                    |        | A             | B   | C   |
| RA107T416 | MEDIUM PLUS M 3P AFP NPT SX TS | 5"                 | 3/4"   | 241           | 133 | 130 |
| RA107T716 | MEDIUM PLUS M 3P BFP NPT SX TS | 5"                 | 1"     | 247           | 145 | 130 |
| RA109T416 | JUNIOR PLUS M 3P AFP NPT SX TS | 7"                 | 3/4"   | 291           | 133 | 130 |
| RA109T716 | JUNIOR PLUS M 3P BFP NPT SX TS | 7"                 | 1"     | 297           | 145 | 130 |
| RA111T416 | SENIOR PLUS M 3P AFP NPT SX TS | 10"                | 3/4"   | 365           | 133 | 130 |
| RA111T716 | SENIOR PLUS M 3P BFP NPT SX TS | 10"                | 1"     | 371           | 145 | 130 |
| RA115T416 | MASTER PLUS M 3P AFP NPT SX TS | 20"                | 3/4"   | 621           | 133 | 130 |
| RA115T716 | MASTER PLUS M 3P BFP NPT SX TS | 20"                | 1"     | 627           | 145 | 130 |

## VARIANTS AVAILABLE ON MINIMUM QUANTITY:

- RT housings suitable for filter cartridges with length 508 mm

Some items in the list are subject to minimum order quantities and/or to longer delivery term.

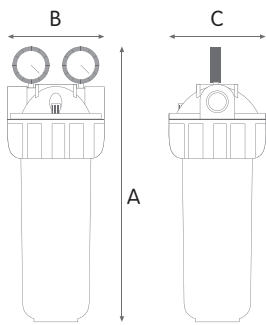

**WORKING CONDITIONS**

Max working pressure:  
 BSP versions \_\_\_\_\_ 8 bar (116 psi)  
 NPT versions \_\_\_\_\_ 8,6 bar (125 psi)  
 Max working temperature \_\_\_\_\_ 45°C (113°F)  
 Min working temperature \_\_\_\_\_ 4°C (39,2°F)

**SPECIFICATIONS**

Non-toxic materials, suitable for drinking water.  
 Head and ring nut: reinforced polypropylene.  
 Bowl: PET.  
 O-ring: EPDM.  
 Breather-valve: body polypropylene, o-ring EPDM.  
 IN/OUT brass threads: CW 614 N brass.  
 Manometers: radial type, pressure range 0-12 bar, 0-170 psi.

**PLUS M 3P SX blue housings with 2 manometers**

**HOUSINGS WITH BRASS BSP THREADS**

| CODE      | MODEL                      | SUITABLE CARTRIDGE | IN/OUT | DIMENSIONS mm |     |     |
|-----------|----------------------------|--------------------|--------|---------------|-----|-----|
|           |                            |                    |        | A             | B   | C   |
| RA107T115 | MEDIUM PLUS M 3P MFO SX AB | 5"                 | 1/2"   | 241           | 133 | 130 |
| RA107T415 | MEDIUM PLUS M 3P AFO SX AB | 5"                 | 3/4"   | 241           | 133 | 130 |
| RA107T715 | MEDIUM PLUS M 3P BFO SX AB | 5"                 | 1"     | 247           | 145 | 130 |
| RA109T115 | JUNIOR PLUS M 3P MFO SX AB | 7"                 | 1/2"   | 291           | 133 | 130 |
| RA109T415 | JUNIOR PLUS M 3P AFO SX AB | 7"                 | 3/4"   | 291           | 133 | 130 |
| RA109T715 | JUNIOR PLUS M 3P BFO SX AB | 7"                 | 1"     | 297           | 145 | 130 |
| RA111T115 | SENIOR PLUS M 3P MFO SX AB | 10"                | 1/2"   | 365           | 133 | 130 |
| RA111T415 | SENIOR PLUS M 3P AFO SX AB | 10"                | 3/4"   | 365           | 133 | 130 |
| RA111T715 | SENIOR PLUS M 3P BFO SX AB | 10"                | 1"     | 371           | 145 | 130 |
| RA115T115 | MASTER PLUS M 3P MFO SX AB | 20"                | 1/2"   | 621           | 133 | 130 |
| RA115T415 | MASTER PLUS M 3P AFO SX AB | 20"                | 3/4"   | 621           | 133 | 130 |
| RA115T715 | MASTER PLUS M 3P BFO SX AB | 20"                | 1"     | 627           | 145 | 130 |

**HOUSINGS WITH PLASTIC BSP THREADS**

| CODE      | MODEL                      | SUITABLE CARTRIDGE | IN/OUT | DIMENSIONS mm |     |     |
|-----------|----------------------------|--------------------|--------|---------------|-----|-----|
|           |                            |                    |        | A             | B   | C   |
| RA107T419 | MEDIUM PLUS M 3P AFP SX AB | 5"                 | 3/4"   | 241           | 133 | 130 |
| RA107T719 | MEDIUM PLUS M 3P BFP SX AB | 5"                 | 1"     | 247           | 145 | 130 |
| RA109T419 | JUNIOR PLUS M 3P AFP SX AB | 7"                 | 3/4"   | 291           | 133 | 130 |
| RA109T719 | JUNIOR PLUS M 3P BFP SX AB | 7"                 | 1"     | 297           | 145 | 130 |
| RA111T419 | SENIOR PLUS M 3P AFP SX AB | 10"                | 3/4"   | 365           | 133 | 130 |
| RA111T719 | SENIOR PLUS M 3P BFP SX AB | 10"                | 1"     | 371           | 145 | 130 |
| RA115T419 | MASTER PLUS M 3P AFP SX AB | 20"                | 3/4"   | 621           | 133 | 130 |
| RA115T719 | MASTER PLUS M 3P BFP SX AB | 20"                | 1"     | 627           | 145 | 130 |

**HOUSINGS WITH PLASTIC NPT THREADS**

| CODE      | MODEL                          | SUITABLE CARTRIDGE | IN/OUT | DIMENSIONS mm |     |     |
|-----------|--------------------------------|--------------------|--------|---------------|-----|-----|
|           |                                |                    |        | A             | B   | C   |
| RA107T417 | MEDIUM PLUS M 3P AFP NPT SX AB | 5"                 | 3/4"   | 241           | 133 | 130 |
| RA107T717 | MEDIUM PLUS M 3P BFP NPT SX AB | 5"                 | 1"     | 247           | 145 | 130 |
| RA109T417 | JUNIOR PLUS M 3P AFP NPT SX AB | 7"                 | 3/4"   | 291           | 133 | 130 |
| RA109T717 | JUNIOR PLUS M 3P BFP NPT SX AB | 7"                 | 1"     | 297           | 145 | 130 |
| RA111T417 | SENIOR PLUS M 3P AFP NPT SX AB | 10"                | 3/4"   | 365           | 133 | 130 |
| RA111T717 | SENIOR PLUS M 3P BFP NPT SX AB | 10"                | 1"     | 371           | 145 | 130 |
| RA115T417 | MASTER PLUS M 3P AFP NPT SX AB | 20"                | 3/4"   | 621           | 133 | 130 |
| RA115T717 | MASTER PLUS M 3P BFP NPT SX AB | 20"                | 1"     | 627           | 145 | 130 |

**VARIANTS AVAILABLE ON MINIMUM QUANTITY:**

- RT housings suitable for filter cartridges with length 508 mm

Some items in the list are subject to minimum order quantities and/or to longer delivery term.



# DUPLEX PLUS 3P SX

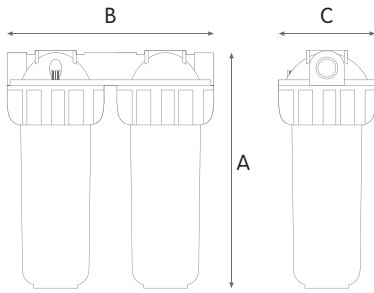

## WORKING CONDITIONS

Max working pressure:  
 BSP versions \_\_\_\_\_ 8 bar (116 psi)  
 NPT versions \_\_\_\_\_ 8,6 bar (125 psi)  
 Max working temperature \_\_\_\_\_ 45°C (113°F)  
 Min working temperature \_\_\_\_\_ 4°C (39,2°F)

## SPECIFICATIONS

Non-toxic materials, suitable for drinking water.  
 Head and ring nut: reinforced polypropylene.  
 Bowl: PET.  
 O-ring: EPDM.  
 Breather-valve: body polypropylene, o-ring EPDM.  
 IN/OUT brass threads: CW 614 N brass.

## DUPLEX PLUS 3P SX clear housings

### HOUSINGS WITH BRASS BSP THREADS

| CODE      | MODEL                           | SUITABLE CARTRIDGE | IN/OUT | DIMENSIONS mm |     |     |
|-----------|---------------------------------|--------------------|--------|---------------|-----|-----|
|           |                                 |                    |        | A             | B   | C   |
| RA108T411 | MEDIUM DUPLEX PLUS 3P AFO SX TS | 5"                 | 3/4"   | 191           | 275 | 130 |
| RA108T711 | MEDIUM DUPLEX PLUS 3P BFO SX TS | 5"                 | 1"     | 191           | 275 | 130 |
| RA110T411 | JUNIOR DUPLEX PLUS 3P AFO SX TS | 7"                 | 3/4"   | 241           | 275 | 130 |
| RA110T711 | JUNIOR DUPLEX PLUS 3P BFO SX TS | 7"                 | 1"     | 241           | 275 | 130 |
| RA112T411 | SENIOR DUPLEX PLUS 3P AFO SX TS | 10"                | 3/4"   | 315           | 275 | 130 |
| RA112T711 | SENIOR DUPLEX PLUS 3P BFO SX TS | 10"                | 1"     | 315           | 275 | 130 |
| RA116T411 | MASTER DUPLEX PLUS 3P AFO SX TS | 20"                | 3/4"   | 571           | 275 | 130 |
| RA116T711 | MASTER DUPLEX PLUS 3P BFO SX TS | 20"                | 1"     | 571           | 275 | 130 |

### HOUSINGS WITH PLASTIC BSP THREADS

| CODE      | MODEL                           | SUITABLE CARTRIDGE | IN/OUT | DIMENSIONS mm |     |     |
|-----------|---------------------------------|--------------------|--------|---------------|-----|-----|
|           |                                 |                    |        | A             | B   | C   |
| RA108T511 | MEDIUM DUPLEX PLUS 3P AFP SX TS | 5"                 | 3/4"   | 191           | 275 | 130 |
| RA110T511 | JUNIOR DUPLEX PLUS 3P AFP SX TS | 7"                 | 3/4"   | 241           | 275 | 130 |
| RA112T511 | SENIOR DUPLEX PLUS 3P AFP SX TS | 10"                | 3/4"   | 315           | 275 | 130 |
| RA116T511 | MASTER DUPLEX PLUS 3P AFP SX TS | 20"                | 3/4"   | 571           | 275 | 130 |

### HOUSINGS WITH PLASTIC NPT THREADS

| CODE      | MODEL                               | SUITABLE CARTRIDGE | IN/OUT | DIMENSIONS mm |     |     |
|-----------|-------------------------------------|--------------------|--------|---------------|-----|-----|
|           |                                     |                    |        | A             | B   | C   |
| RA108T513 | MEDIUM DUPLEX PLUS 3P AFP NPT SX TS | 5"                 | 3/4"   | 191           | 275 | 130 |
| RA110T513 | JUNIOR DUPLEX PLUS 3P AFP NPT SX TS | 7"                 | 3/4"   | 241           | 275 | 130 |
| RA112T611 | SENIOR DUPLEX PLUS 3P AFP NPT SX TS | 10"                | 3/4"   | 315           | 275 | 130 |
| RA116T611 | MASTER DUPLEX PLUS 3P AFP NPT SX TS | 20"                | 3/4"   | 571           | 275 | 130 |

## VARIANTS AVAILABLE ON MINIMUM QUANTITY:

- RT housings suitable for filter cartridges with length 508 mm

Some items in the list are subject to minimum order quantities and/or to longer delivery term.



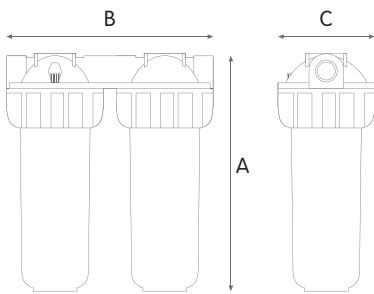

**WORKING CONDITIONS**

Max working pressure:  
 BSP versions \_\_\_\_\_ 8 bar (116 psi)  
 NPT versions \_\_\_\_\_ 8,6 bar (125 psi)  
 Max working temperature \_\_\_\_\_ 45°C (113°F)  
 Min working temperature \_\_\_\_\_ 4°C (39,2°F)

**SPECIFICATIONS**

Non-toxic materials, suitable for drinking water.  
 Head and ring nut: reinforced polypropylene.  
 Bowl: PET.  
 O-ring: EPDM.  
 Breather-valve: body polypropylene, o-ring EPDM.  
 IN/OUT brass threads: CW 614 N brass.

**DUPLEX PLUS 3P SX blue housings**

**HOUSINGS WITH BRASS BSP THREADS**

| CODE      | MODEL                           | SUITABLE CARTRIDGE | IN/OUT | DIMENSIONS mm |     |     |
|-----------|---------------------------------|--------------------|--------|---------------|-----|-----|
|           |                                 |                    |        | A             | B   | C   |
| RA108T412 | MEDIUM DUPLEX PLUS 3P AFO SX AB | 5"                 | 3/4"   | 191           | 275 | 130 |
| RA108T712 | MEDIUM DUPLEX PLUS 3P BFO SX AB | 5"                 | 1"     | 191           | 275 | 130 |
| RA110T412 | JUNIOR DUPLEX PLUS 3P AFO SX AB | 7"                 | 3/4"   | 241           | 275 | 130 |
| RA110T712 | JUNIOR DUPLEX PLUS 3P BFO SX AB | 7"                 | 1"     | 241           | 275 | 130 |
| RA112T412 | SENIOR DUPLEX PLUS 3P AFO SX AB | 10"                | 3/4"   | 315           | 275 | 130 |
| RA112T712 | SENIOR DUPLEX PLUS 3P BFO SX AB | 10"                | 1"     | 315           | 275 | 130 |
| RA116T412 | MASTER DUPLEX PLUS 3P AFO SX AB | 20"                | 3/4"   | 571           | 275 | 130 |
| RA116T712 | MASTER DUPLEX PLUS 3P BFO SX AB | 20"                | 1"     | 571           | 275 | 130 |

**HOUSINGS WITH PLASTIC BSP THREADS**

| CODE      | MODEL                           | SUITABLE CARTRIDGE | IN/OUT | DIMENSIONS mm |     |     |
|-----------|---------------------------------|--------------------|--------|---------------|-----|-----|
|           |                                 |                    |        | A             | B   | C   |
| RA108T512 | MEDIUM DUPLEX PLUS 3P AFP SX AB | 5"                 | 3/4"   | 191           | 275 | 130 |
| RA110T512 | JUNIOR DUPLEX PLUS 3P AFP SX AB | 7"                 | 3/4"   | 241           | 275 | 130 |
| RA112T512 | SENIOR DUPLEX PLUS 3P AFP SX AB | 10"                | 3/4"   | 315           | 275 | 130 |
| RA116T512 | MASTER DUPLEX PLUS 3P AFP SX AB | 20"                | 3/4"   | 571           | 275 | 130 |

**HOUSINGS WITH PLASTIC NPT THREADS**

| CODE      | MODEL                               | SUITABLE CARTRIDGE | IN/OUT | DIMENSIONS mm |     |     |
|-----------|-------------------------------------|--------------------|--------|---------------|-----|-----|
|           |                                     |                    |        | A             | B   | C   |
| RA108T514 | MEDIUM DUPLEX PLUS 3P AFP NPT SX AB | 5"                 | 3/4"   | 191           | 275 | 130 |
| RA110T514 | JUNIOR DUPLEX PLUS 3P AFP NPT SX AB | 7"                 | 3/4"   | 241           | 275 | 130 |
| RA112T612 | SENIOR DUPLEX PLUS 3P AFP NPT SX AB | 10"                | 3/4"   | 315           | 275 | 130 |
| RA116T612 | MASTER DUPLEX PLUS 3P AFP NPT SX AB | 20"                | 3/4"   | 571           | 275 | 130 |

**VARIANTS AVAILABLE ON MINIMUM QUANTITY:**

- RT housings suitable for filter cartridges with length 508 mm

Some items in the list are subject to minimum order quantities and/or to longer delivery term.



# TRIPLEX PLUS 3P SX

## WORKING CONDITIONS

Max working pressure:  
 BSP versions \_\_\_\_\_ 8 bar (116 psi)  
 NPT versions \_\_\_\_\_ 8,6 bar (125 psi)  
 Max working temperature \_\_\_\_\_ 45°C (113°F)  
 Min working temperature \_\_\_\_\_ 4°C (39,2°F)

## SPECIFICATIONS

Non-toxic materials, suitable for drinking water.  
 Head and ring nut: reinforced polypropylene.  
 Bowl: PET.  
 O-ring: EPDM.  
 Breather-valve: body polypropylene, o-ring EPDM.  
 IN/OUT brass threads: CW 614 N brass.

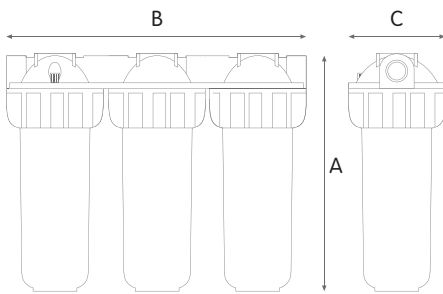

## TRIPLEX PLUS 3P SX clear housings

### HOUSINGS WITH BRASS BSP THREADS

| CODE      | MODEL                            | SUITABLE CARTRIDGE | IN/OUT | DIMENSIONS mm |     |     |
|-----------|----------------------------------|--------------------|--------|---------------|-----|-----|
|           |                                  |                    |        | A             | B   | C   |
| RA108T431 | MEDIUM TRIPLEX PLUS 3P AFO SX TS | 5"                 | 3/4"   | 191           | 420 | 130 |
| RA108T731 | MEDIUM TRIPLEX PLUS 3P BFO SX TS | 5"                 | 1"     | 191           | 420 | 130 |
| RA110T431 | JUNIOR TRIPLEX PLUS 3P AFO SX TS | 7"                 | 3/4"   | 241           | 420 | 130 |
| RA110T731 | JUNIOR TRIPLEX PLUS 3P BFO SX TS | 7"                 | 1"     | 241           | 420 | 130 |
| RA112T431 | SENIOR TRIPLEX PLUS 3P AFO SX TS | 10"                | 3/4"   | 315           | 420 | 130 |
| RA112T731 | SENIOR TRIPLEX PLUS 3P BFO SX TS | 10"                | 1"     | 315           | 420 | 130 |
| RA116T431 | MASTER TRIPLEX PLUS 3P AFO SX TS | 20"                | 3/4"   | 571           | 420 | 130 |
| RA116T731 | MASTER TRIPLEX PLUS 3P BFO SX TS | 20"                | 1"     | 571           | 420 | 130 |

### HOUSINGS WITH PLASTIC BSP THREADS

| CODE      | MODEL                            | SUITABLE CARTRIDGE | IN/OUT | DIMENSIONS mm |     |     |
|-----------|----------------------------------|--------------------|--------|---------------|-----|-----|
|           |                                  |                    |        | A             | B   | C   |
| RA108T531 | MEDIUM TRIPLEX PLUS 3P AFP SX TS | 5"                 | 3/4"   | 191           | 420 | 130 |
| RA108T831 | MEDIUM TRIPLEX PLUS 3P BFP SX TS | 5"                 | 1"     | 191           | 420 | 130 |
| RA110T531 | JUNIOR TRIPLEX PLUS 3P AFP SX TS | 7"                 | 3/4"   | 241           | 420 | 130 |
| RA110T831 | JUNIOR TRIPLEX PLUS 3P BFP SX TS | 7"                 | 1"     | 241           | 420 | 130 |
| RA112T531 | SENIOR TRIPLEX PLUS 3P AFP SX TS | 10"                | 3/4"   | 315           | 420 | 130 |
| RA112T831 | SENIOR TRIPLEX PLUS 3P BFP SX TS | 10"                | 1"     | 315           | 420 | 130 |
| RA116T531 | MASTER TRIPLEX PLUS 3P AFP SX TS | 20"                | 3/4"   | 571           | 420 | 130 |
| RA116T831 | MASTER TRIPLEX PLUS 3P BFP SX TS | 20"                | 1"     | 571           | 420 | 130 |

### HOUSINGS WITH PLASTIC NPT THREADS

| CODE      | MODEL                                | SUITABLE CARTRIDGE | IN/OUT | DIMENSIONS mm |     |     |
|-----------|--------------------------------------|--------------------|--------|---------------|-----|-----|
|           |                                      |                    |        | A             | B   | C   |
| RA108T533 | MEDIUM TRIPLEX PLUS 3P AFP NPT SX TS | 5"                 | 3/4"   | 191           | 420 | 130 |
| RA110T533 | JUNIOR TRIPLEX PLUS 3P AFP NPT SX TS | 7"                 | 3/4"   | 241           | 420 | 130 |
| RA112T533 | SENIOR TRIPLEX PLUS 3P AFP NPT SX TS | 10"                | 3/4"   | 315           | 420 | 130 |
| RA116T533 | MASTER TRIPLEX PLUS 3P AFP NPT SX TS | 20"                | 3/4"   | 571           | 420 | 130 |

## VARIANTS AVAILABLE ON MINIMUM QUANTITY:

- RT housings suitable for filter cartridges with length 508 mm

Some items in the list are subject to minimum order quantities and/or to longer delivery term.

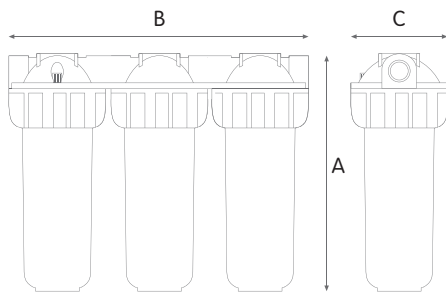

**WORKING CONDITIONS**

Max working pressure:  
 BSP versions \_\_\_\_\_ 8 bar (116 psi)  
 NPT versions \_\_\_\_\_ 8,6 bar (125 psi)  
 Max working temperature \_\_\_\_\_ 45°C (113°F)  
 Min working temperature \_\_\_\_\_ 4°C (39,2°F)

**SPECIFICATIONS**

Non-toxic materials, suitable for drinking water.  
 Head and ring nut: reinforced polypropylene.  
 Bowl: PET.  
 O-ring: EPDM.  
 Breather-valve: body polypropylene, o-ring EPDM.  
 IN/OUT brass threads: CW 614 N brass.

**TRIPLEX PLUS 3P SX blue housings**

**HOUSINGS WITH BRASS BSP THREADS**

| CODE      | MODEL                            | SUITABLE CARTRIDGE | IN/OUT | DIMENSIONS mm |     |     |
|-----------|----------------------------------|--------------------|--------|---------------|-----|-----|
|           |                                  |                    |        | A             | B   | C   |
| RA108T432 | MEDIUM TRIPLEX PLUS 3P AFO SX AB | 5"                 | 3/4"   | 191           | 420 | 130 |
| RA108T732 | MEDIUM TRIPLEX PLUS 3P BFO SX AB | 5"                 | 1"     | 191           | 420 | 130 |
| RA110T432 | JUNIOR TRIPLEX PLUS 3P AFO SX AB | 7"                 | 3/4"   | 241           | 420 | 130 |
| RA110T732 | JUNIOR TRIPLEX PLUS 3P BFO SX AB | 7"                 | 1"     | 241           | 420 | 130 |
| RA112T432 | SENIOR TRIPLEX PLUS 3P AFO SX AB | 10"                | 3/4"   | 315           | 420 | 130 |
| RA112T732 | SENIOR TRIPLEX PLUS 3P BFO SX AB | 10"                | 1"     | 315           | 420 | 130 |
| RA116T432 | MASTER TRIPLEX PLUS 3P AFO SX AB | 20"                | 3/4"   | 571           | 420 | 130 |
| RA116T732 | MASTER TRIPLEX PLUS 3P BFO SX AB | 20"                | 1"     | 571           | 420 | 130 |

**HOUSINGS WITH PLASTIC BSP THREADS**

| CODE      | MODEL                            | SUITABLE CARTRIDGE | IN/OUT | DIMENSIONS mm |     |     |
|-----------|----------------------------------|--------------------|--------|---------------|-----|-----|
|           |                                  |                    |        | A             | B   | C   |
| RA108T532 | MEDIUM TRIPLEX PLUS 3P AFP SX AB | 5"                 | 3/4"   | 191           | 420 | 130 |
| RA108T832 | MEDIUM TRIPLEX PLUS 3P BFP SX AB | 5"                 | 1"     | 191           | 420 | 130 |
| RA110T532 | JUNIOR TRIPLEX PLUS 3P AFP SX AB | 7"                 | 3/4"   | 241           | 420 | 130 |
| RA110T832 | JUNIOR TRIPLEX PLUS 3P BFP SX AB | 7"                 | 1"     | 241           | 420 | 130 |
| RA112T532 | SENIOR TRIPLEX PLUS 3P AFP SX AB | 10"                | 3/4"   | 315           | 420 | 130 |
| RA112T832 | SENIOR TRIPLEX PLUS 3P BFP SX AB | 10"                | 1"     | 315           | 420 | 130 |
| RA116T532 | MASTER TRIPLEX PLUS 3P AFP SX AB | 20"                | 3/4"   | 571           | 420 | 130 |
| RA116T832 | MASTER TRIPLEX PLUS 3P BFP SX AB | 20"                | 1"     | 571           | 420 | 130 |

**HOUSINGS WITH PLASTIC NPT THREADS**

| CODE      | MODEL                                | SUITABLE CARTRIDGE | IN/OUT | DIMENSIONS mm |     |     |
|-----------|--------------------------------------|--------------------|--------|---------------|-----|-----|
|           |                                      |                    |        | A             | B   | C   |
| RA108T534 | MEDIUM TRIPLEX PLUS 3P AFP NPT SX AB | 5"                 | 3/4"   | 191           | 420 | 130 |
| RA110T534 | JUNIOR TRIPLEX PLUS 3P AFP NPT SX AB | 7"                 | 3/4"   | 241           | 420 | 130 |
| RA112T534 | SENIOR TRIPLEX PLUS 3P AFP NPT SX AB | 10"                | 3/4"   | 315           | 420 | 130 |
| RA116T534 | MASTER TRIPLEX PLUS 3P AFP NPT SX AB | 20"                | 3/4"   | 571           | 420 | 130 |

**VARIANTS AVAILABLE ON MINIMUM QUANTITY:**

- RT housings suitable for filter cartridges with length 508 mm

Some items in the list are subject to minimum order quantities and/or to longer delivery term.



# PLUS 2P SX

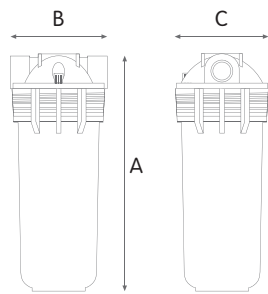

## WORKING CONDITIONS

Max working pressure \_\_\_\_\_ 8 bar (116 psi)  
 Max working temperature \_\_\_\_\_ 45°C (113°F)  
 Min working temperature \_\_\_\_\_ 4°C (39,2°F)

## SPECIFICATIONS

Non-toxic materials, suitable for drinking water.  
 Head: reinforced polypropylene.  
 Bowl: SAN.  
 O-ring: EPDM.  
 Breather-valve: body polypropylene, o-ring EPDM.  
 IN/OUT brass threads: CW 614 N brass.

## PLUS 2P SX clear housings

### HOUSINGS WITH BRASS BSP THREADS

| CODE      | MODEL                    | SUITABLE CARTRIDGE | IN/OUT | DIMENSIONS mm |     |     |
|-----------|--------------------------|--------------------|--------|---------------|-----|-----|
|           |                          |                    |        | A             | B   | C   |
| RA117P111 | CADET PLUS 2P MFO SX AS  | 4"                 | 1/2"   | 169           | 133 | 130 |
| RA117P411 | CADET PLUS 2P AFO SX AS  | 4"                 | 3/4"   | 169           | 133 | 130 |
| RA117P711 | CADET PLUS 2P BFO SX AS  | 4"                 | 1"     | 173           | 145 | 130 |
| RA119P111 | JUNIOR PLUS 2P MFO SX AS | 7"                 | 1/2"   | 241           | 133 | 130 |
| RA119P411 | JUNIOR PLUS 2P AFO SX AS | 7"                 | 3/4"   | 241           | 133 | 130 |
| RA119P711 | JUNIOR PLUS 2P BFO SX AS | 7"                 | 1"     | 247           | 145 | 130 |
| RA121P111 | SENIOR PLUS 2P MFO SX AS | 10"                | 1/2"   | 315           | 133 | 130 |
| RA121P411 | SENIOR PLUS 2P AFO SX AS | 10"                | 3/4"   | 315           | 133 | 130 |
| RA121P711 | SENIOR PLUS 2P BFO SX AS | 10"                | 1"     | 321           | 145 | 130 |

### HOUSINGS WITH PLASTIC BSP THREADS

| CODE      | MODEL                    | SUITABLE CARTRIDGE | IN/OUT | DIMENSIONS mm |     |     |
|-----------|--------------------------|--------------------|--------|---------------|-----|-----|
|           |                          |                    |        | A             | B   | C   |
| RA117P211 | CADET PLUS 2P MFP SX AS  | 4"                 | 1/2"   | 169           | 133 | 130 |
| RA117P511 | CADET PLUS 2P AFP SX AS  | 4"                 | 3/4"   | 169           | 133 | 130 |
| RA117P811 | CADET PLUS 2P BFP SX AS  | 4"                 | 1"     | 173           | 145 | 130 |
| RA119P211 | JUNIOR PLUS 2P MFP SX AS | 7"                 | 1/2"   | 241           | 133 | 130 |
| RA119P511 | JUNIOR PLUS 2P AFP SX AS | 7"                 | 3/4"   | 241           | 133 | 130 |
| RA119P811 | JUNIOR PLUS 2P BFP SX AS | 7"                 | 1"     | 247           | 145 | 130 |
| RA121P211 | SENIOR PLUS 2P MFP SX AS | 10"                | 1/2"   | 315           | 133 | 130 |
| RA121P511 | SENIOR PLUS 2P AFP SX AS | 10"                | 3/4"   | 315           | 133 | 130 |
| RA121P811 | SENIOR PLUS 2P BFP SX AS | 10"                | 1"     | 321           | 145 | 130 |

### HOUSINGS WITH PLASTIC NPT THREADS

| CODE      | MODEL                        | SUITABLE CARTRIDGE | IN/OUT | DIMENSIONS mm |     |     |
|-----------|------------------------------|--------------------|--------|---------------|-----|-----|
|           |                              |                    |        | A             | B   | C   |
| RA117P516 | CADET PLUS 2P AFP NPT SX AS  | 4"                 | 3/4"   | 169           | 133 | 130 |
| RA117P816 | CADET PLUS 2P BFP NPT SX AS  | 4"                 | 1"     | 173           | 145 | 130 |
| RA119P516 | JUNIOR PLUS 2P AFP NPT SX AS | 7"                 | 3/4"   | 241           | 133 | 130 |
| RA119P816 | JUNIOR PLUS 2P BFP NPT SX AS | 7"                 | 1"     | 247           | 145 | 130 |
| RA121P516 | SENIOR PLUS 2P AFP NPT SX AS | 10"                | 3/4"   | 315           | 133 | 130 |
| RA121P816 | SENIOR PLUS 2P BFP NPT SX AS | 10"                | 1"     | 321           | 145 | 130 |

### HOUSINGS WITH PLASTIC BSP THREADS

| CODE      | MODEL                    | SUITABLE CARTRIDGE | IN/OUT | DIMENSIONS mm |     |     |
|-----------|--------------------------|--------------------|--------|---------------|-----|-----|
|           |                          |                    |        | A             | B   | C   |
| RA117P214 | CADET PLUS 2P MMP SX AS  | 4"                 | 1/2"   | 169           | 175 | 130 |
| RA117P514 | CADET PLUS 2P AMP SX AS  | 4"                 | 3/4"   | 169           | 175 | 130 |
| RA117P814 | CADET PLUS 2P BMP SX AS  | 4"                 | 1"     | 173           | 175 | 130 |
| RA119P214 | JUNIOR PLUS 2P MMP SX AS | 7"                 | 1/2"   | 241           | 175 | 130 |
| RA119P514 | JUNIOR PLUS 2P AMP SX AS | 7"                 | 3/4"   | 241           | 175 | 130 |
| RA119P814 | JUNIOR PLUS 2P BMP SX AS | 7"                 | 1"     | 247           | 175 | 130 |
| RA121P214 | SENIOR PLUS 2P MMP SX AS | 10"                | 1/2"   | 315           | 175 | 130 |
| RA121P514 | SENIOR PLUS 2P AMP SX AS | 10"                | 3/4"   | 315           | 175 | 130 |
| RA121P814 | SENIOR PLUS 2P BMP SX AS | 10"                | 1"     | 321           | 175 | 130 |

Some items in the list are subject to minimum order quantities and/or to longer delivery term.

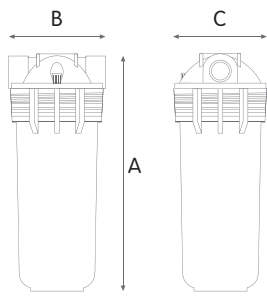

**WORKING CONDITIONS**

Max working pressure \_\_\_\_\_ 8 bar (116 psi)  
 Max working temperature \_\_\_\_\_ 45°C (113°F)  
 Min working temperature \_\_\_\_\_ 4°C (39,2°F)

**SPECIFICATIONS**

Non-toxic materials, suitable for drinking water.  
 Head: reinforced polypropylene.  
 Bowl: reinforced polypropylene.  
 O-ring: EPDM.  
 Breather-valve: body polypropylene, o-ring EPDM.  
 IN/OUT brass threads: CW 614 N brass.

**PLUS 2P SX blue housings**

**HOUSINGS WITH BRASS BSP THREADS**

| CODE      | MODEL                    | SUITABLE CARTRIDGE | IN/OUT | DIMENSIONS mm |     |     |
|-----------|--------------------------|--------------------|--------|---------------|-----|-----|
|           |                          |                    |        | A             | B   | C   |
| RA117P112 | CADET PLUS 2P MFO SX AB  | 4"                 | 1/2"   | 169           | 133 | 130 |
| RA117P412 | CADET PLUS 2P AFO SX AB  | 4"                 | 3/4"   | 169           | 133 | 130 |
| RA117P712 | CADET PLUS 2P BFO SX AB  | 4"                 | 1"     | 173           | 145 | 130 |
| RA119P112 | JUNIOR PLUS 2P MFO SX AB | 7"                 | 1/2"   | 241           | 133 | 130 |
| RA119P412 | JUNIOR PLUS 2P AFO SX AB | 7"                 | 3/4"   | 241           | 133 | 130 |
| RA119P712 | JUNIOR PLUS 2P BFO SX AB | 7"                 | 1"     | 247           | 145 | 130 |
| RA121P112 | SENIOR PLUS 2P MFO SX AB | 10"                | 1/2"   | 315           | 133 | 130 |
| RA121P412 | SENIOR PLUS 2P AFO SX AB | 10"                | 3/4"   | 315           | 133 | 130 |
| RA121P712 | SENIOR PLUS 2P BFO SX AB | 10"                | 1"     | 321           | 145 | 130 |

**HOUSINGS WITH PLASTIC BSP THREADS**

| CODE      | MODEL                    | SUITABLE CARTRIDGE | IN/OUT | DIMENSIONS mm |     |     |
|-----------|--------------------------|--------------------|--------|---------------|-----|-----|
|           |                          |                    |        | A             | B   | C   |
| RA117P212 | CADET PLUS 2P MFP SX AB  | 4"                 | 1/2"   | 169           | 133 | 130 |
| RA117P512 | CADET PLUS 2P AFP SX AB  | 4"                 | 3/4"   | 169           | 133 | 130 |
| RA117P812 | CADET PLUS 2P BFP SX AB  | 4"                 | 1"     | 173           | 145 | 130 |
| RA119P212 | JUNIOR PLUS 2P MFP SX AB | 7"                 | 1/2"   | 241           | 133 | 130 |
| RA119P512 | JUNIOR PLUS 2P AFP SX AB | 7"                 | 3/4"   | 241           | 133 | 130 |
| RA119P812 | JUNIOR PLUS 2P BFP SX AB | 7"                 | 1"     | 247           | 145 | 130 |
| RA121P212 | SENIOR PLUS 2P MFP SX AB | 10"                | 1/2"   | 315           | 133 | 130 |
| RA121P512 | SENIOR PLUS 2P AFP SX AB | 10"                | 3/4"   | 315           | 133 | 130 |
| RA121P812 | SENIOR PLUS 2P BFP SX AB | 10"                | 1"     | 321           | 145 | 130 |

**HOUSINGS WITH PLASTIC NPT THREADS**

| CODE      | MODEL                        | SUITABLE CARTRIDGE | IN/OUT | DIMENSIONS mm |     |     |
|-----------|------------------------------|--------------------|--------|---------------|-----|-----|
|           |                              |                    |        | A             | B   | C   |
| RA117P517 | CADET PLUS 2P AFP NPT SX AB  | 4"                 | 3/4"   | 169           | 133 | 130 |
| RA117P817 | CADET PLUS 2P BFP NPT SX AB  | 4"                 | 1"     | 173           | 145 | 130 |
| RA119P517 | JUNIOR PLUS 2P AFP NPT SX AB | 7"                 | 3/4"   | 241           | 133 | 130 |
| RA119P817 | JUNIOR PLUS 2P BFP NPT SX AB | 7"                 | 1"     | 247           | 145 | 130 |
| RA121P517 | SENIOR PLUS 2P AFP NPT SX AB | 10"                | 3/4"   | 315           | 133 | 130 |
| RA121P817 | SENIOR PLUS 2P BFP NPT SX AB | 10"                | 1"     | 321           | 145 | 130 |

**HOUSINGS WITH PLASTIC BSP THREADS**

| CODE      | MODEL                    | SUITABLE CARTRIDGE | IN/OUT | DIMENSIONS mm |     |     |
|-----------|--------------------------|--------------------|--------|---------------|-----|-----|
|           |                          |                    |        | A             | B   | C   |
| RA117P215 | CADET PLUS 2P MMP SX AB  | 4"                 | 1/2"   | 169           | 175 | 130 |
| RA117P515 | CADET PLUS 2P AMP SX AB  | 4"                 | 3/4"   | 169           | 175 | 130 |
| RA117P815 | CADET PLUS 2P BMP SX AB  | 4"                 | 1"     | 173           | 175 | 130 |
| RA119P215 | JUNIOR PLUS 2P MMP SX AB | 7"                 | 1/2"   | 241           | 175 | 130 |
| RA119P515 | JUNIOR PLUS 2P AMP SX AB | 7"                 | 3/4"   | 241           | 175 | 130 |
| RA119P815 | JUNIOR PLUS 2P BMP SX AB | 7"                 | 1"     | 247           | 175 | 130 |
| RA121P215 | SENIOR PLUS 2P MMP SX AB | 10"                | 1/2"   | 315           | 175 | 130 |
| RA121P515 | SENIOR PLUS 2P AMP SX AB | 10"                | 3/4"   | 315           | 175 | 130 |
| RA121P815 | SENIOR PLUS 2P BMP SX AB | 10"                | 1"     | 321           | 175 | 130 |

Some items in the list are subject to minimum order quantities and/or to longer delivery term.



# PLUS M 2P SX

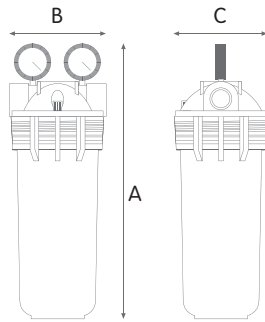

## WORKING CONDITIONS

Max working pressure \_\_\_\_\_ 8 bar (116 psi)  
 Max working temperature \_\_\_\_\_ 45°C (113°F)  
 Min working temperature \_\_\_\_\_ 4°C (39,2°F)

## SPECIFICATIONS

Non-toxic materials, suitable for drinking water.  
 Head: reinforced polypropylene.  
 Bowl: SAN.  
 O-ring: EPDM.  
 Breather-valve: body polypropylene, o-ring EPDM.  
 IN/OUT brass threads: CW 614 N brass.  
 Manometers: radial type, pressure range 0-12 bar, 0-170 psi.

## PLUS M 2P SX clear housings with 2 manometers

### HOUSINGS WITH BRASS BSP THREADS

| CODE      | MODEL                      | SUITABLE CARTRIDGE | IN/OUT | DIMENSIONS mm |     |     |
|-----------|----------------------------|--------------------|--------|---------------|-----|-----|
|           |                            |                    |        | A             | B   | C   |
| RA117P114 | CADET PLUS M 2P MFO SX AS  | 4"                 | 1/2"   | 219           | 133 | 130 |
| RA117P414 | CADET PLUS M 2P AFO SX AS  | 4"                 | 3/4"   | 219           | 133 | 130 |
| RA117P714 | CADET PLUS M 2P BFO SX AS  | 4"                 | 1"     | 225           | 145 | 130 |
| RA119P114 | JUNIOR PLUS M 2P MFO SX AS | 7"                 | 1/2"   | 291           | 133 | 130 |
| RA119P414 | JUNIOR PLUS M 2P AFO SX AS | 7"                 | 3/4"   | 291           | 133 | 130 |
| RA119P714 | JUNIOR PLUS M 2P BFO SX AS | 7"                 | 1"     | 297           | 145 | 130 |
| RA121P114 | SENIOR PLUS M 2P MFO SX AS | 10"                | 1/2"   | 365           | 133 | 130 |
| RA121P414 | SENIOR PLUS M 2P AFO SX AS | 10"                | 3/4"   | 365           | 133 | 130 |
| RA121P714 | SENIOR PLUS M 2P BFO SX AS | 10"                | 1"     | 371           | 145 | 130 |

### HOUSINGS WITH PLASTIC BSP THREADS

| CODE      | MODEL                      | SUITABLE CARTRIDGE | IN/OUT | DIMENSIONS mm |     |     |
|-----------|----------------------------|--------------------|--------|---------------|-----|-----|
|           |                            |                    |        | A             | B   | C   |
| RA117P418 | CADET PLUS M 2P AFP SX AS  | 4"                 | 3/4"   | 219           | 133 | 130 |
| RA117P718 | CADET PLUS M 2P BFP SX AS  | 4"                 | 1"     | 225           | 145 | 130 |
| RA119P418 | JUNIOR PLUS M 2P AFP SX AS | 7"                 | 3/4"   | 291           | 133 | 130 |
| RA119P718 | JUNIOR PLUS M 2P BFP SX AS | 7"                 | 1"     | 297           | 145 | 130 |
| RA121P418 | SENIOR PLUS M 2P AFP SX AS | 10"                | 3/4"   | 365           | 133 | 130 |
| RA121P718 | SENIOR PLUS M 2P BFP SX AS | 10"                | 1"     | 371           | 145 | 130 |

### HOUSINGS WITH PLASTIC NPT THREADS

| CODE      | MODEL                          | SUITABLE CARTRIDGE | IN/OUT | DIMENSIONS mm |     |     |
|-----------|--------------------------------|--------------------|--------|---------------|-----|-----|
|           |                                |                    |        | A             | B   | C   |
| RA117P518 | CADET PLUS M 2P AFP NPT SX AS  | 4"                 | 3/4"   | 219           | 133 | 130 |
| RA117P818 | CADET PLUS M 2P BFP NPT SX AS  | 4"                 | 1"     | 225           | 145 | 130 |
| RA119P518 | JUNIOR PLUS M 2P AFP NPT SX AS | 7"                 | 3/4"   | 291           | 133 | 130 |
| RA119P818 | JUNIOR PLUS M 2P BFP NPT SX AS | 7"                 | 1"     | 297           | 145 | 130 |
| RA121P518 | SENIOR PLUS M 2P AFP NPT SX AS | 10"                | 3/4"   | 365           | 133 | 130 |
| RA121P818 | SENIOR PLUS M 2P BFP NPT SX AS | 10"                | 1"     | 371           | 145 | 130 |

Some items in the list are subject to minimum order quantities and/or to longer delivery term.

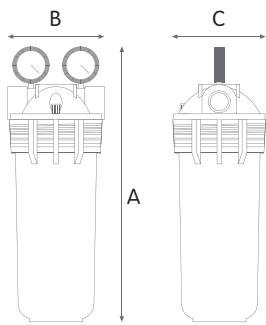

**WORKING CONDITIONS**

Max working pressure \_\_\_\_\_ 8 bar (116 psi)  
 Max working temperature \_\_\_\_\_ 45°C (113°F)  
 Min working temperature \_\_\_\_\_ 4°C (39,2°F)

**SPECIFICATIONS**

Non-toxic materials, suitable for drinking water.  
 Head: reinforced polypropylene.  
 Bowl: reinforced polypropylene.  
 O-ring: EPDM.  
 Breather-valve: body polypropylene, o-ring EPDM.  
 IN/OUT brass threads: CW 614 N brass.  
 Manometers: radial type, pressure range 0-12 bar, 0-170 psi.

**PLUS M 2P SX blue housings with 2 manometers**

**HOUSINGS WITH BRASS BSP THREADS**

| CODE      | MODEL                      | SUITABLE CARTRIDGE | IN/OUT | DIMENSIONS mm |     |     |
|-----------|----------------------------|--------------------|--------|---------------|-----|-----|
|           |                            |                    |        | A             | B   | C   |
| RA117P115 | CADET PLUS M 2P MFO SX AB  | 4"                 | 1/2"   | 219           | 133 | 130 |
| RA117P415 | CADET PLUS M 2P AFO SX AB  | 4"                 | 3/4"   | 219           | 133 | 130 |
| RA117P715 | CADET PLUS M 2P BFO SX AB  | 4"                 | 1"     | 225           | 145 | 130 |
| RA119P115 | JUNIOR PLUS M 2P MFO SX AB | 7"                 | 1/2"   | 291           | 133 | 130 |
| RA119P415 | JUNIOR PLUS M 2P AFO SX AB | 7"                 | 3/4"   | 291           | 133 | 130 |
| RA119P715 | JUNIOR PLUS M 2P BFO SX AB | 7"                 | 1"     | 297           | 145 | 130 |
| RA121P115 | SENIOR PLUS M 2P MFO SX AB | 10"                | 1/2"   | 365           | 133 | 130 |
| RA121P415 | SENIOR PLUS M 2P AFO SX AB | 10"                | 3/4"   | 365           | 133 | 130 |
| RA121P715 | SENIOR PLUS M 2P BFO SX AB | 10"                | 1"     | 371           | 145 | 130 |

**HOUSINGS WITH PLASTIC BSP THREADS**

| CODE      | MODEL                      | SUITABLE CARTRIDGE | IN/OUT | DIMENSIONS mm |     |     |
|-----------|----------------------------|--------------------|--------|---------------|-----|-----|
|           |                            |                    |        | A             | B   | C   |
| RA117P419 | CADET PLUS M 2P AFP SX AB  | 4"                 | 3/4"   | 219           | 133 | 130 |
| RA117P719 | CADET PLUS M 2P BFP SX AB  | 4"                 | 1"     | 225           | 145 | 130 |
| RA119P419 | JUNIOR PLUS M 2P AFP SX AB | 7"                 | 3/4"   | 291           | 133 | 130 |
| RA119P719 | JUNIOR PLUS M 2P BFP SX AB | 7"                 | 1"     | 297           | 145 | 130 |
| RA121P419 | SENIOR PLUS M 2P AFP SX AB | 10"                | 3/4"   | 365           | 133 | 130 |
| RA121P719 | SENIOR PLUS M 2P BFP SX AB | 10"                | 1"     | 371           | 145 | 130 |

**HOUSINGS WITH PLASTIC NPT THREADS**

| CODE      | MODEL                          | SUITABLE CARTRIDGE | IN/OUT | DIMENSIONS mm |     |     |
|-----------|--------------------------------|--------------------|--------|---------------|-----|-----|
|           |                                |                    |        | A             | B   | C   |
| RA117P519 | CADET PLUS M 2P AFP NPT SX AB  | 4"                 | 3/4"   | 219           | 133 | 130 |
| RA117P819 | CADET PLUS M 2P BFP NPT SX AB  | 4"                 | 1"     | 225           | 145 | 130 |
| RA119P519 | JUNIOR PLUS M 2P AFP NPT SX AB | 7"                 | 3/4"   | 291           | 133 | 130 |
| RA119P819 | JUNIOR PLUS M 2P BFP NPT SX AB | 7"                 | 1"     | 297           | 145 | 130 |
| RA121P519 | SENIOR PLUS M 2P AFP NPT SX AB | 10"                | 3/4"   | 365           | 133 | 130 |
| RA121P819 | SENIOR PLUS M 2P BFP NPT SX AB | 10"                | 1"     | 371           | 145 | 130 |

Some items in the list are subject to minimum order quantities and/or to longer delivery term.



# DUPLEX PLUS 2P SX

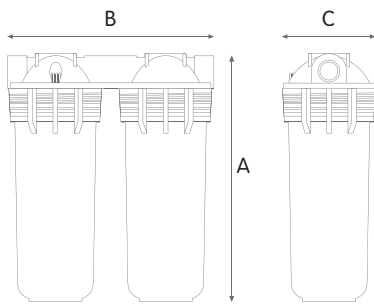

## WORKING CONDITIONS

Max working pressure \_\_\_\_\_ 8 bar (116 psi)  
 Max working temperature \_\_\_\_\_ 45°C (113°F)  
 Min working temperature \_\_\_\_\_ 4°C (39,2°F)

## SPECIFICATIONS

Non-toxic materials, suitable for drinking water.  
 Head: reinforced polypropylene.  
 Bowl: SAN.  
 O-ring: EPDM.  
 Breather-valve: body polypropylene, o-ring EPDM.  
 IN/OUT brass threads: CW 614 N brass.

## DUPLEX PLUS 2P SX clear housings

### HOUSINGS WITH BRASS BSP THREADS

| CODE      | MODEL                           | SUITABLE CARTRIDGE | IN/OUT | DIMENSIONS mm |     |     |
|-----------|---------------------------------|--------------------|--------|---------------|-----|-----|
|           |                                 |                    |        | A             | B   | C   |
| RA118P411 | CADET DUPLEX PLUS 2P AF0 SX AS  | 4"                 | 3/4"   | 169           | 275 | 130 |
| RA118P711 | CADET DUPLEX PLUS 2P BF0 SX AS  | 4"                 | 1"     | 169           | 275 | 130 |
| RA120P411 | JUNIOR DUPLEX PLUS 2P AF0 SX AS | 7"                 | 3/4"   | 241           | 275 | 130 |
| RA120P711 | JUNIOR DUPLEX PLUS 2P BF0 SX AS | 7"                 | 1"     | 241           | 275 | 130 |
| RA122P411 | SENIOR DUPLEX PLUS 2P AF0 SX AS | 10"                | 3/4"   | 315           | 275 | 130 |
| RA122P711 | SENIOR DUPLEX PLUS 2P BF0 SX AS | 10"                | 1"     | 315           | 275 | 130 |

### HOUSINGS WITH PLASTIC BSP THREADS

| CODE      | MODEL                           | SUITABLE CARTRIDGE | IN/OUT | DIMENSIONS mm |     |     |
|-----------|---------------------------------|--------------------|--------|---------------|-----|-----|
|           |                                 |                    |        | A             | B   | C   |
| RA118P511 | CADET DUPLEX PLUS 2P AFP SX AS  | 4"                 | 3/4"   | 169           | 275 | 130 |
| RA120P511 | JUNIOR DUPLEX PLUS 2P AFP SX AS | 7"                 | 3/4"   | 241           | 275 | 130 |
| RA122P511 | SENIOR DUPLEX PLUS 2P AFP SX AS | 10"                | 3/4"   | 315           | 275 | 130 |

### HOUSINGS WITH PLASTIC NPT THREADS

| CODE      | MODEL                               | SUITABLE CARTRIDGE | IN/OUT | DIMENSIONS mm |     |     |
|-----------|-------------------------------------|--------------------|--------|---------------|-----|-----|
|           |                                     |                    |        | A             | B   | C   |
| RA118P513 | CADET DUPLEX PLUS 2P AFP NPT SX AS  | 4"                 | 3/4"   | 169           | 275 | 130 |
| RA120P513 | JUNIOR DUPLEX PLUS 2P AFP NPT SX AS | 7"                 | 3/4"   | 241           | 275 | 130 |
| RA122P513 | SENIOR DUPLEX PLUS 2P AFP NPT SX AS | 10"                | 3/4"   | 315           | 275 | 130 |

Some items in the list are subject to minimum order quantities and/or to longer delivery term.



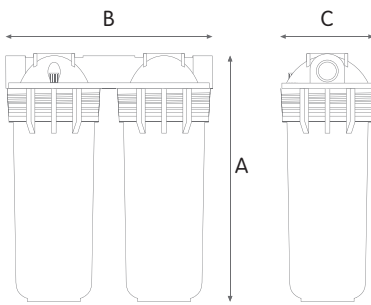

**WORKING CONDITIONS**

Max working pressure \_\_\_\_\_ 8 bar (116 psi)  
 Max working temperature \_\_\_\_\_ 45°C (113°F)  
 Min working temperature \_\_\_\_\_ 4°C (39,2°F)

**SPECIFICATIONS**

Non-toxic materials, suitable for drinking water.  
 Head: reinforced polypropylene.  
 Bowl: reinforced polypropylene.  
 O-ring: EPDM.  
 Breather-valve: body polypropylene, o-ring EPDM.  
 IN/OUT brass threads: CW 614 N brass.

**DUPLEX PLUS 2P SX blue housings**

**HOUSINGS WITH BRASS BSP THREADS**

| CODE      | MODEL                           | SUITABLE CARTRIDGE | IN/OUT | DIMENSIONS mm |     |     |
|-----------|---------------------------------|--------------------|--------|---------------|-----|-----|
|           |                                 |                    |        | A             | B   | C   |
| RA118P412 | CADET DUPLEX PLUS 2P AFO SX AB  | 4"                 | 3/4"   | 169           | 275 | 130 |
| RA118P712 | CADET DUPLEX PLUS 2P BFO SX AB  | 4"                 | 1"     | 169           | 275 | 130 |
| RA120P412 | JUNIOR DUPLEX PLUS 2P AFO SX AB | 7"                 | 3/4"   | 241           | 275 | 130 |
| RA120P712 | JUNIOR DUPLEX PLUS 2P BFO SX AB | 7"                 | 1"     | 241           | 275 | 130 |
| RA122P412 | SENIOR DUPLEX PLUS 2P AFO SX AB | 10"                | 3/4"   | 315           | 275 | 130 |
| RA122P712 | SENIOR DUPLEX PLUS 2P BFO SX AB | 10"                | 1"     | 315           | 275 | 130 |

**HOUSINGS WITH PLASTIC BSP THREADS**

| CODE      | MODEL                           | SUITABLE CARTRIDGE | IN/OUT | DIMENSIONS mm |     |     |
|-----------|---------------------------------|--------------------|--------|---------------|-----|-----|
|           |                                 |                    |        | A             | B   | C   |
| RA118P512 | CADET DUPLEX PLUS 2P AFP SX AB  | 4"                 | 3/4"   | 169           | 275 | 130 |
| RA120P512 | JUNIOR DUPLEX PLUS 2P AFP SX AB | 7"                 | 3/4"   | 241           | 275 | 130 |
| RA122P512 | SENIOR DUPLEX PLUS 2P AFP SX AB | 10"                | 3/4"   | 315           | 275 | 130 |

**HOUSINGS WITH PLASTIC NPT THREADS**

| CODE      | MODEL                               | SUITABLE CARTRIDGE | IN/OUT | DIMENSIONS mm |     |     |
|-----------|-------------------------------------|--------------------|--------|---------------|-----|-----|
|           |                                     |                    |        | A             | B   | C   |
| RA118P514 | CADET DUPLEX PLUS 2P AFP NPT SX AB  | 4"                 | 3/4"   | 169           | 275 | 130 |
| RA120P514 | JUNIOR DUPLEX PLUS 2P AFP NPT SX AB | 7"                 | 3/4"   | 241           | 275 | 130 |
| RA122P514 | SENIOR DUPLEX PLUS 2P AFP NPT SX AB | 10"                | 3/4"   | 315           | 275 | 130 |

Some items in the list are subject to minimum order quantities and/or to longer delivery term.



# TRIPLEX PLUS 2P SX

## WORKING CONDITIONS

Max working pressure \_\_\_\_\_ 8 bar (116 psi)  
 Max working temperature \_\_\_\_\_ 45°C (113°F)  
 Min working temperature \_\_\_\_\_ 4°C (39,2°F)

## SPECIFICATIONS

Non-toxic materials, suitable for drinking water.  
 Head: reinforced polypropylene.  
 Bowl: SAN.  
 O-ring: EPDM.  
 Breather-valve: body polypropylene, o-ring EPDM.  
 IN/OUT brass threads: CW 614 N brass.

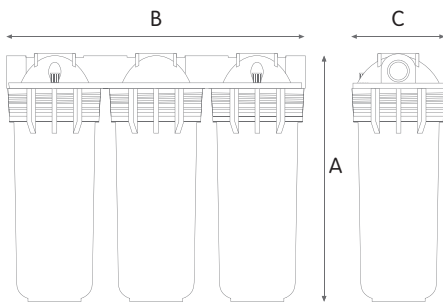

## TRIPLEX PLUS 2P SX clear housings

### HOUSINGS WITH BRASS BSP THREADS

| CODE      | MODEL                            | SUITABLE CARTRIDGE | IN/OUT | DIMENSIONS mm |     |     |
|-----------|----------------------------------|--------------------|--------|---------------|-----|-----|
|           |                                  |                    |        | A             | B   | C   |
| RA118P431 | CADET TRIPLEX PLUS 2P AFO SX AS  | 4"                 | 3/4"   | 169           | 420 | 130 |
| RA118P731 | CADET TRIPLEX PLUS 2P BFO SX AS  | 4"                 | 1"     | 169           | 420 | 130 |
| RA120P431 | JUNIOR TRIPLEX PLUS 2P AFO SX AS | 7"                 | 3/4"   | 241           | 420 | 130 |
| RA120P731 | JUNIOR TRIPLEX PLUS 2P BFO SX AS | 7"                 | 1"     | 241           | 420 | 130 |
| RA122P431 | SENIOR TRIPLEX PLUS 2P AFO SX AS | 10"                | 3/4"   | 315           | 420 | 130 |
| RA122P731 | SENIOR TRIPLEX PLUS 2P BFO SX AS | 10"                | 1"     | 315           | 420 | 130 |

### HOUSINGS WITH PLASTIC BSP THREADS

| CODE      | MODEL                            | SUITABLE CARTRIDGE | IN/OUT | DIMENSIONS mm |     |     |
|-----------|----------------------------------|--------------------|--------|---------------|-----|-----|
|           |                                  |                    |        | A             | B   | C   |
| RA118P531 | CADET TRIPLEX PLUS 2P AFP SX AS  | 4"                 | 3/4"   | 169           | 420 | 130 |
| RA118P831 | CADET TRIPLEX PLUS 2P BFP SX AS  | 4"                 | 1"     | 169           | 420 | 130 |
| RA120P531 | JUNIOR TRIPLEX PLUS 2P AFP SX AS | 7"                 | 3/4"   | 241           | 420 | 130 |
| RA120P831 | JUNIOR TRIPLEX PLUS 2P BFP SX AS | 7"                 | 1"     | 241           | 420 | 130 |
| RA122P531 | SENIOR TRIPLEX PLUS 2P AFP SX AS | 10"                | 3/4"   | 315           | 420 | 130 |
| RA122P831 | SENIOR TRIPLEX PLUS 2P BFP SX AS | 10"                | 1"     | 315           | 420 | 130 |

### HOUSINGS WITH PLASTIC NPT THREADS

| CODE      | MODEL                                | SUITABLE CARTRIDGE | IN/OUT | DIMENSIONS mm |     |     |
|-----------|--------------------------------------|--------------------|--------|---------------|-----|-----|
|           |                                      |                    |        | A             | B   | C   |
| RA118P533 | CADET TRIPLEX PLUS 2P AFP NPT SX AS  | 4"                 | 3/4"   | 169           | 420 | 130 |
| RA120P533 | JUNIOR TRIPLEX PLUS 2P AFP NPT SX AS | 7"                 | 3/4"   | 241           | 420 | 130 |
| RA122P533 | SENIOR TRIPLEX PLUS 2P AFP NPT SX AS | 10"                | 3/4"   | 315           | 420 | 130 |

Some items in the list are subject to minimum order quantities and/or to longer delivery term.

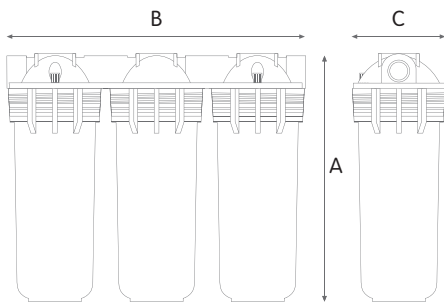

**WORKING CONDITIONS**

Max working pressure \_\_\_\_\_ 8 bar (116 psi)  
 Max working temperature \_\_\_\_\_ 45°C (113°F)  
 Min working temperature \_\_\_\_\_ 4°C (39,2°F)

**SPECIFICATIONS**

Non-toxic materials, suitable for drinking water.  
 Head: reinforced polypropylene.  
 Bowl: reinforced polypropylene.  
 O-ring: EPDM.  
 Breather-valve: body polypropylene, o-ring EPDM.  
 IN/OUT brass threads: CW 614 N brass.

**TRIPLEX PLUS 2P SX blue housings**

**HOUSINGS WITH BRASS BSP THREADS**

| CODE      | MODEL                            | SUITABLE CARTRIDGE | IN/OUT | DIMENSIONS mm |     |     |
|-----------|----------------------------------|--------------------|--------|---------------|-----|-----|
|           |                                  |                    |        | A             | B   | C   |
| RA118P432 | CADET TRIPLEX PLUS 2P AFO SX AB  | 4"                 | 3/4"   | 169           | 420 | 130 |
| RA118P732 | CADET TRIPLEX PLUS 2P BFO SX AB  | 4"                 | 1"     | 169           | 420 | 130 |
| RA120P432 | JUNIOR TRIPLEX PLUS 2P AFO SX AB | 7"                 | 3/4"   | 241           | 420 | 130 |
| RA120P732 | JUNIOR TRIPLEX PLUS 2P BFO SX AB | 7"                 | 1"     | 241           | 420 | 130 |
| RA122P432 | SENIOR TRIPLEX PLUS 2P AFO SX AB | 10"                | 3/4"   | 315           | 420 | 130 |
| RA122P732 | SENIOR TRIPLEX PLUS 2P BFO SX AB | 10"                | 1"     | 315           | 420 | 130 |

**HOUSINGS WITH PLASTIC BSP THREADS**

| CODE      | MODEL                            | SUITABLE CARTRIDGE | IN/OUT | DIMENSIONS mm |     |     |
|-----------|----------------------------------|--------------------|--------|---------------|-----|-----|
|           |                                  |                    |        | A             | B   | C   |
| RA118P532 | CADET TRIPLEX PLUS 2P AFP SX AB  | 4"                 | 3/4"   | 169           | 420 | 130 |
| RA118P832 | CADET TRIPLEX PLUS 2P BFP SX AB  | 4"                 | 1"     | 169           | 420 | 130 |
| RA120P532 | JUNIOR TRIPLEX PLUS 2P AFP SX AB | 7"                 | 3/4"   | 241           | 420 | 130 |
| RA120P832 | JUNIOR TRIPLEX PLUS 2P BFP SX AB | 7"                 | 1"     | 241           | 420 | 130 |
| RA122P532 | SENIOR TRIPLEX PLUS 2P AFP SX AB | 10"                | 3/4"   | 315           | 420 | 130 |
| RA122P832 | SENIOR TRIPLEX PLUS 2P BFP SX AB | 10"                | 1"     | 315           | 420 | 130 |

**HOUSINGS WITH PLASTIC NPT THREADS**

| CODE      | MODEL                                | SUITABLE CARTRIDGE | IN/OUT | DIMENSIONS mm |     |     |
|-----------|--------------------------------------|--------------------|--------|---------------|-----|-----|
|           |                                      |                    |        | A             | B   | C   |
| RA118P534 | CADET TRIPLEX PLUS 2P AFP NPT SX AB  | 4"                 | 3/4"   | 169           | 420 | 130 |
| RA120P534 | JUNIOR TRIPLEX PLUS 2P AFP NPT SX AB | 7"                 | 3/4"   | 241           | 420 | 130 |
| RA122P534 | SENIOR TRIPLEX PLUS 2P AFP NPT SX AB | 10"                | 3/4"   | 315           | 420 | 130 |

Some items in the list are subject to minimum order quantities and/or to longer delivery term.